

# COE-G Series

GigE Camera

USER MANUAL

---

# User Manual

## About this Manual

This Manual is applicable to COE-G series cameras.

The Manual includes instructions for using and managing the product. Pictures, charts, images and all other information hereinafter are for description and explanation only. The information contained in the Manual is subject to change, without notice, due to firmware updates or other reasons. Please find the latest version in the company website.

Please use this user manual under the guidance of professionals.

## Legal Disclaimer

TO THE MAXIMUM EXTENT PERMITTED BY APPLICABLE LAW, THE PRODUCT DESCRIBED, WITH ITS HARDWARE, SOFTWARE AND FIRMWARE, IS PROVIDED "AS IS", WITH ALL FAULTS AND ERRORS, AND OUR COMPANY MAKES NO WARRANTIES, EXPRESS OR IMPLIED, INCLUDING WITHOUT LIMITATION, MERCHANTABILITY, SATISFACTORY QUALITY, FITNESS FOR A PARTICULAR PURPOSE, AND NON-INFRINGEMENT OF THIRD PARTY. IN NO EVENT WILL OUR COMPANY, ITS DIRECTORS, OFFICERS, EMPLOYEES, OR AGENTS BE LIABLE TO YOU FOR ANY SPECIAL, CONSEQUENTIAL, INCIDENTAL, OR INDIRECT DAMAGES, INCLUDING, AMONG OTHERS, DAMAGES FOR LOSS OF BUSINESS PROFITS, BUSINESS INTERRUPTION, OR LOSS OF DATA OR DOCUMENTATION, IN CONNECTION WITH THE USE OF THIS PRODUCT, EVEN IF OUR COMPANY HAS BEEN ADVISED OF THE POSSIBILITY OF SUCH DAMAGES. REGARDING TO THE PRODUCT WITH INTERNET ACCESS, THE USE OF PRODUCT SHALL BE WHOLLY AT YOUR OWN RISKS. OUR COMPANY SHALL NOT TAKE ANY RESPONSIBILITIES FOR ABNORMAL OPERATION, PRIVACY LEAKAGE OR OTHER DAMAGES RESULTING FROM CYBER ATTACK, HACKER ATTACK, VIRUS INSPECTION, OR OTHER INTERNET SECURITY RISKS; HOWEVER, OUR COMPANY WILL PROVIDE TIMELY TECHNICAL SUPPORT IF REQUIRED.

SURVEILLANCE LAWS VARY BY JURISDICTION. PLEASE CHECK ALL RELEVANT LAWS IN YOUR JURISDICTION BEFORE USING THIS PRODUCT IN ORDER TO ENSURE THAT YOUR USE CONFORMS THE APPLICABLE LAW. OUR COMPANY SHALL NOT BE LIABLE IN THE EVENT THAT THIS PRODUCT IS USED WITH ILLEGITIMATE PURPOSES. IN THE EVENT OF ANY CONFLICTS BETWEEN THIS MANUAL AND THE APPLICABLE LAW, THE LATER PREVAILS.

## Regulatory Information

### EU Conformity Statement



This product and - if applicable - the supplied accessories too are marked with "CE" and comply therefore with the applicable harmonized European standards listed under the EMC Directive 2004/108/EC, the RoHS Directive 2011/65/EU.



2012/19/EU (WEEE directive): Products marked with this symbol cannot be disposed of as unsorted municipal waste in the European Union. For proper recycling, return this product to your local supplier upon the purchase of equivalent new equipment, or dispose of it at designated collection points. For more information see: [www.recyclethis.info](http://www.recyclethis.info).

## Safety Instruction

These instructions are intended to ensure that the user can use the product correctly to avoid danger or property loss. The precaution measure is divided into 'Warnings' and 'Cautions':

**Warnings:** Serious injury or death may be caused if any of these warnings are neglected.

**Cautions:** Injury or equipment damage may be caused if any of these cautions are neglected.



**Warnings** Follow these safeguards to prevent serious injury or death.

**Cautions** Follow these precautions to prevent potential injury or material damage.



**Warnings:**

- Please adopt the power adapter which can meet the safety extra low voltage (SELV) standard. And source with 12 VDC (depending on models) according to the IEC60950-1 and Limited Power Source standard.
- To reduce the risk of fire or electrical shock, do not expose this product to rain or moisture.
- This installation should be made by a qualified service person and should conform to all the local codes.
- Please install blackouts equipment into the power supply circuit for convenient supply interruption.
- Please make sure that the ceiling can support more than 50(N) Newton gravities if the camera is fixed to the ceiling.
- If the product does not work properly, please contact your dealer or the nearest service center. Never attempt to disassemble the camera yourself. (We shall not assume any responsibility for problems caused by unauthorized repair or maintenance.)



**Cautions:**

- Make sure the power supply voltage is correct before using the camera.
- Do not drop the camera or subject it to physical shock.
- Do not touch sensor modules with fingers. If cleaning is necessary, use a clean cloth with a bit of ethanol and wipe it gently. If the camera will not be used for an extended period of time, put on the lens cap to protect the sensor from dirt.
- Do not aim the camera lens at the strong light such as sun or incandescent lamp. The strong light can cause fatal damage to the camera.
- The sensor may be burned out by a laser beam, so when any laser equipment is being used, make sure that the surface of the sensor not be exposed to the laser beam.
- Do not place the camera in extremely hot, cold temperatures (the operating temperature should be between -0°C to 50°C), dusty or damp environment, and do not expose it to high electromagnetic radiation.
- To avoid heat accumulation, ensure there is good ventilation to the device.
- Keep the camera away from water and any liquids.
- While shipping, pack the camera in its original, or equivalent, packing materials. Or packing the same texture.
- Improper use or replacement of the battery may result in hazard of explosion. Please use the manufacturer recommended battery type.

## Part Number

Part number	Description	Type Structure
COE-003-x-POE-010-yy-C	CMOS, Python 300, 1/4", GIGE, 640x480, 4.8pix, 173fps ,C-mount	Type I
COE-004-x-POE-010-yy-C	CMOS, Python 300, 1/4", GIGE, 640x480, 4.8pix, 300fps ,C-mount	Type I
COE-003-x-POE-020-yy-C	CCD, RJ33B4AD0DT, 1/3", GIGE, 640x480, 7.4pix, 200fps ,C-mount	Type I
COE-012-x-POE-020-yy-C	CCD, RJ33J4CA3DE, 1/3", GIGE, 1280x960, 3.75pix, 30fps ,C-mount	Type I
COE-004-x-POE-021-yy-C	CMOS, IMX287, 1/2.9", GIGE, 720x540, 6.9pix, 291fps ,C-mount	Type I
COE-016-x-POE-021-yy-C	CMOS, IMX273, 1/2.9", GIGE, 1440x1080, 3.45pix, 70fps ,C-mount	Type I
COE-050-M-POE-023-IR-C	CMOS, MT9P031, 1/2.5", GIGE, 2592x1944, 2.2pix, 14fps ,C-mount	Type I
COE-013-x-POE-030-yy-C	CMOS, Python1300, 1/2", GIGE, 1280x1024, 4.8pix, 90fps ,C-mount	Type I
COE-106-x-POE-031-yy-C	CMOS, MT9J003, 1/2.3", GIGE, 3840x2748, 1.67pix, 11fps ,C-mount	Type I
COE-032-x-POE-040-yy-C	CMOS, IMX265, 1/1.8", GIGE, 2064x1544, 3.45pix, 35fps ,C-mount	Type I
COE-063-x-POE-040-yy-C	CMOS, IMX178, 1/1.8", GIGE, 3096x2080, 2.4pix, 17fps ,C-mount	Type I
COE-122-x-POE-041-yy-C	CMOS, IMX226, 1/1.7", GIGE, 4024x3036, 1.85pix, 9fps ,C-mount	Type I
COE-023-x-POE-050-yy-C	CMOS, PYTHON 2000, 2/3", GIGE, 1920x1200, 4.8pix, 50fps ,C-mount	Type I
COE-050-x-POE-050-yy-C	CMOS, IMX264, 2/3", GIGE, 2464x2056, 3.45pix, 23fps ,C-mount	Type I
COE-023-x-POE-060-yy-C	CMOS, IMX249, 1/1.2", GIGE, 1936x1216, 5.86pix, 40fps ,C-mount	Type I
COE-053-x-POE-070-yy-C	CMOS, Python 5000, 1", GIGE, 2592x2048, 4.8pix, 20fps ,C-mount	Type I
COE-089-x-POE-070-yy-C	CMOS, IMX267, 1", GIGE, 4112x2176, 3.45pix, 13fps ,C-mount	Type II
COE-123-x-POE-080-yy-C	CMOS, IMX304, 1.1", GIGE, 4112x3008, 3.45pix, 9fps ,C-mount	Type II

## How to Order

X	M = Monochrome C = Color
YY	Glass/Infrared cut filter supported

# Table of Contents

<b>Chapter 1</b>	<b>Overview.....</b>	<b>6</b>
1.1	Introduction.....	6
1.2	Main Features.....	6
1.3	Camera Physical Interfaces.....	6
1.3.1	Camera Dimension.....	6
1.3.2	Rear Panel Introduction.....	7
1.3.3	Power and I/O Interface Introduction.....	8
1.3.4	Installation Accessories.....	8
<b>Chapter 2</b>	<b>Camera Installation and Configuration.....</b>	<b>9</b>
2.1	Installing the Camera.....	9
2.2	Network Configuration.....	9
2.2.1	Local Network Configuration.....	9
2.2.2	Camera IP Configuration.....	10
2.3	Camera Configuration.....	12
2.3.1	Setting via Attribute Tree.....	12
<b>Chapter 3</b>	<b>Functions.....</b>	<b>15</b>
3.1	Device Control.....	15
3.1.1	Name Modification.....	15
3.2	Image Format and Frame Rate.....	16
3.2.1	Camera Data Format.....	16
3.2.2	Frame Rate.....	17
3.3	Global Shutter and Rolling Shutter.....	19
3.3.1	Global Shutter.....	19
3.3.2	Rolling Shutter.....	19
3.4	Image Acquisition and Transmission.....	21
3.4.1	Internal Trigger Mode.....	21
3.4.2	External Trigger Signal and Working Mode.....	21
3.5	Strobe Output.....	23
3.6	Acquisition Mode under External Trigger.....	24
3.7	Overlap Exposure and Non-overlap Exposure.....	26
3.7.1	Non-overlap Exposure.....	26
3.7.2	Overlap Exposure.....	26
3.8	Counter Control.....	27
3.9	Imaging Parameter Setting.....	29
3.9.1	Exposure Time.....	29
3.9.2	Gain Control.....	29
3.9.3	White balance.....	30
3.9.4	Region Setting of Auto Functions.....	30
3.9.5	Look Up Table (LUT).....	31
3.9.6	Gamma Correction.....	31
3.9.7	Brightness, Hue and Saturation.....	32



---

3.9.8	Image Reverse .....	33
3.9.9	HDR Cycling Mode.....	33
3.9.10	Test pattern .....	34
<b>3.10</b>	<b>I/O Electric Feature .....</b>	<b>36</b>
3.10.1	Line0 Opto-isolated Input Circuit .....	36
3.10.2	Line1 Opto-isolated Output Circuit .....	37
3.10.3	Line2 Configurable Bi-direction I/O Circuit .....	38
<b>3.11</b>	<b>Transport Layer Control .....</b>	<b>39</b>
3.11.1	DHCP and Persistent IP .....	39
3.11.2	Efficient Bandwidth and Setting.....	40
<b>3.12</b>	<b>User Parameter and Preference Setting.....</b>	<b>41</b>
3.12.1	Parameters Saving and Loading .....	41
3.12.2	Embedded Information .....	42
<b>3.13</b>	<b>Firmware Updating .....</b>	<b>43</b>
<b>Chapter 4</b>	<b><i>Troubleshooting</i>.....</b>	<b>45</b>
<b>4.1</b>	<b>Indicator Status Definition.....</b>	<b>45</b>
<b>4.2</b>	<b>Indicator Status Description.....</b>	<b>45</b>
<b>4.3</b>	<b>FAQ .....</b>	<b>46</b>

# Chapter 1 Overview

## 1.1 Introduction

The COE camera is an image capturing device capable of real-time transmission of uncompressed image through a gigabit Ethernet interface. Remote image capturing and camera control, for example, the operating mode and the image parameters adjustment, are supported by client software.

## 1.2 Main Features

- The gigabit Ethernet interface provides the bandwidth of 1 Gbps and reaches the maximum transmission distance of 100 meters.
- 128 MB onboard memory stores images for burst transmission and retransmission.
- Supports AEC (automatic exposure control), LUT, Gamma Correction, etc..
- Use hardware external trigger or software trigger to synchronize several cameras or cameras with external devices.
- Supports image capturing with different exposure modes.
- The color camera adopts the color interpolation algorithm to reproduce colors faithfully. It also supports automatic white balance (AWB).
- Compatible with GigE Vision Protocol (V1.2) and third-party software.

**Note:**

The functions in this manual are for reference only and may differ from the devices.

## 1.3 Camera Physical Interfaces

### 1.3.1 Camera Dimension

The mechanical dimension of the COE-G camera is shown below. The camera should be installed with M3\*3 or M2\*3 screws.

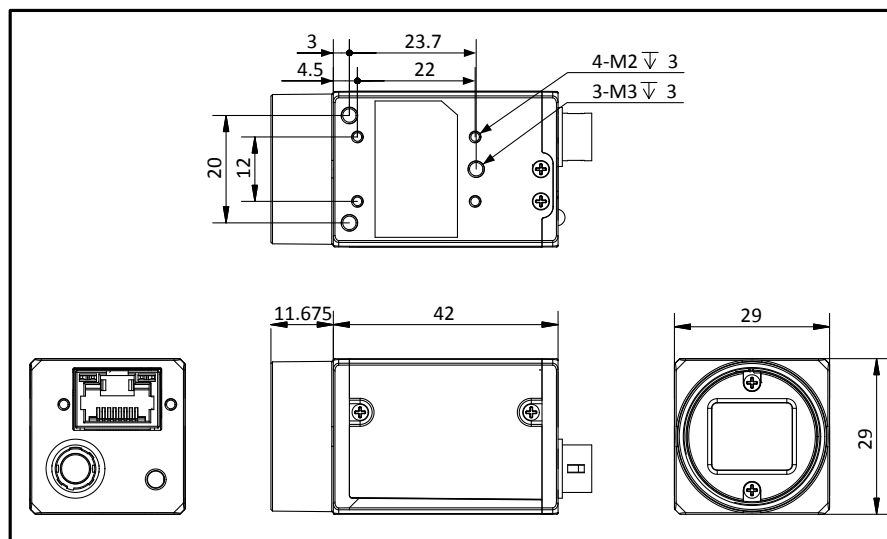

Figure 1-1 Dimension of Type I Models

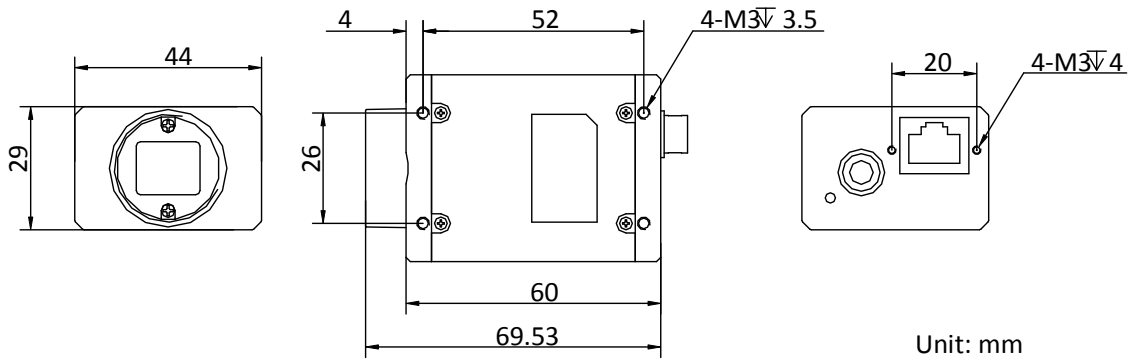

Figure 1-2 Dimension of Type II Models

**Note:**

The camera adopts the C-Mount lens interface. The flange back length of lens is 17.5mm±0.15mm.

**1.3.2 Rear Panel Introduction**

The rear panel of the COE camera is shown in the figure below.

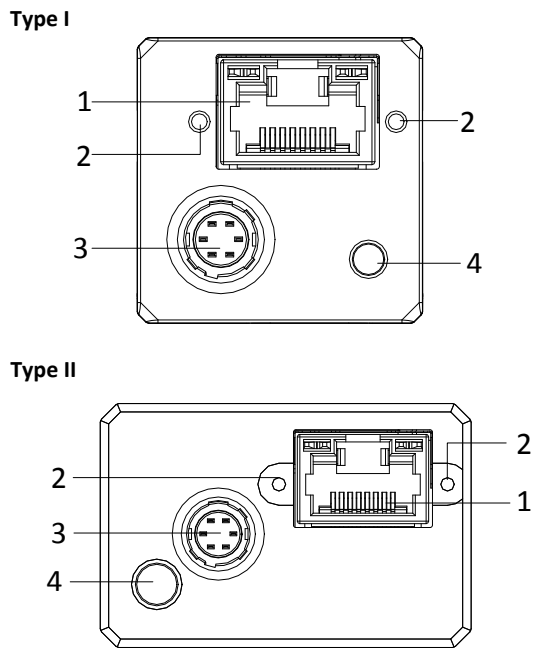

Figure 1-3 Rear Panel

Table 1-1 Description of the Rear Panel

No.	Description
1	RJ45 gigabit Ethernet interface
2	M2 screw holes for network cable securing
3	6-pin power and I/O interface
4	Status indicator LED



### 1.3.3 Power and I/O Interface Introduction

The description of the 6-pin power and I/O connector is shown in the table below.

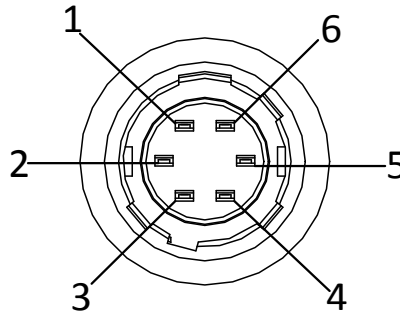

Figure 1-4 Power and I/O Interface

Table 1-2 Description

No.	Signal	I/O Type	Description
1	12V	Input	DC 12V
2	Opt-Iso In	Input	Opto-isolated input
3	GPIO	Input/output	Can be configured as input or output
4	Opt-Iso Out	Output	Opto-isolated output
5	I/O Ground	Input	Opt- isolated I/O grounding
6	GND	Input	Power and GPIO grounding

### 1.3.4 Installation Accessories

Prepare the installation accessories listed below before you install the COE camera.

Table 1-3 Accessory List

No.	Accessory Name	Number	Description
1	Camera	1	The COE camera.
2	Power I/O cable	1	The 6-pin cable or extension cable.
3	Power adapter	1	12V DC power adapter (Min. 1A)
4	Ethernet cable with proper length	1	CAT-5e or CAT-6 Ethernet cable
5	Lens (Optional)	1	C-Mount Lens
6	Mounting Bracket (Optional)	1	The mounting bracket has four M2 holes and one 1/4-32UNF interface.

---

## Chapter 2

## Camera Installation and Configuration

### 2.1 Installing the Camera

Steps:

1. Unpack the camera package and install the lens (optional) to the camera body by rotating the lens clockwise.
2. Fix the camera to the desired position.
3. Use CAT-5e or CAT-6 network cable to connect the camera with a switch or a network card.
4. Choose a power supply method.
  - Direct supply: Use the supplied cord with a 6-pin power and I/O interface to connect the camera to a power adapter (DC 12V for the camera).
  - PoE (Power over Ethernet): Use a network cable to connect the camera to a switch or a network card that supports PoE function.

**Note:**

The COE network camera adopts a gigabit network interface. To guarantee the bandwidth for real-time image transmission, you need to use a CAT-5e or CAT-6 network cable.

### 2.2 Network Configuration

Purpose:

Before using the camera, you need to configure the IP address of the camera. The IP addresses of the camera and the local computer should belong to the same network segment. You can use the ping command on the local computer to test the network connectivity.

Before you start:

Download the OESC control client from OPTO-E.COM website in the specific series download page. Refer to the *User Manual of O ECS Client Software* for details.

#### 2.2.1 Local Network Configuration

Steps:

1. Click Start -> Control Panel -> Network and Internet -> Network and Sharing Center -> Change adapter settings, select the network connection and click Properties.
2. Double click the TCP protocol, and you can set select **Obtain an IP address automatically**.
3. (Optional) You can also select **Use the following IP address**, and set the IP address as the same subnet with the camera.

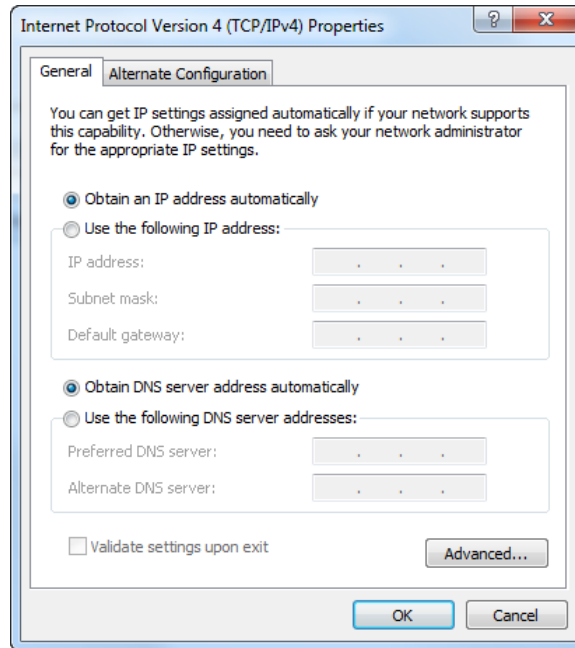

Figure 2-1 IP Address Setting

4. Click **OK** to save the settings.
5. You also need to enable the jumbo frame of the NIC. For different operating systems, the path to setting the jumbo frame may be different. Here we take Windows 7 as an example.
  - 1) Click Start -> Control Panel -> Hardware and Sound -> Device Manager -> Network adapters, double click the NIC to enter its properties interface.
  - 2) Click **Advanced** tab.
  - 3) Select **Jumbo Frame** from the property list and select the value as **9KB MTU**.
  - 4) Click **OK** to save the settings.

**Note:**

Jumbo frame is not supported by some types of NIC. We recommend you to use the NIC which supports jumbo frame for better image transmission.

## 2.2.2 Camera IP Configuration

You can use the client software to complete network configuration for the camera.

Steps:

1. Double click the "OECS IP Configurator.exe" to open the configuration tool. You can find the tool in the installation directory.
2. Select the camera to configure.

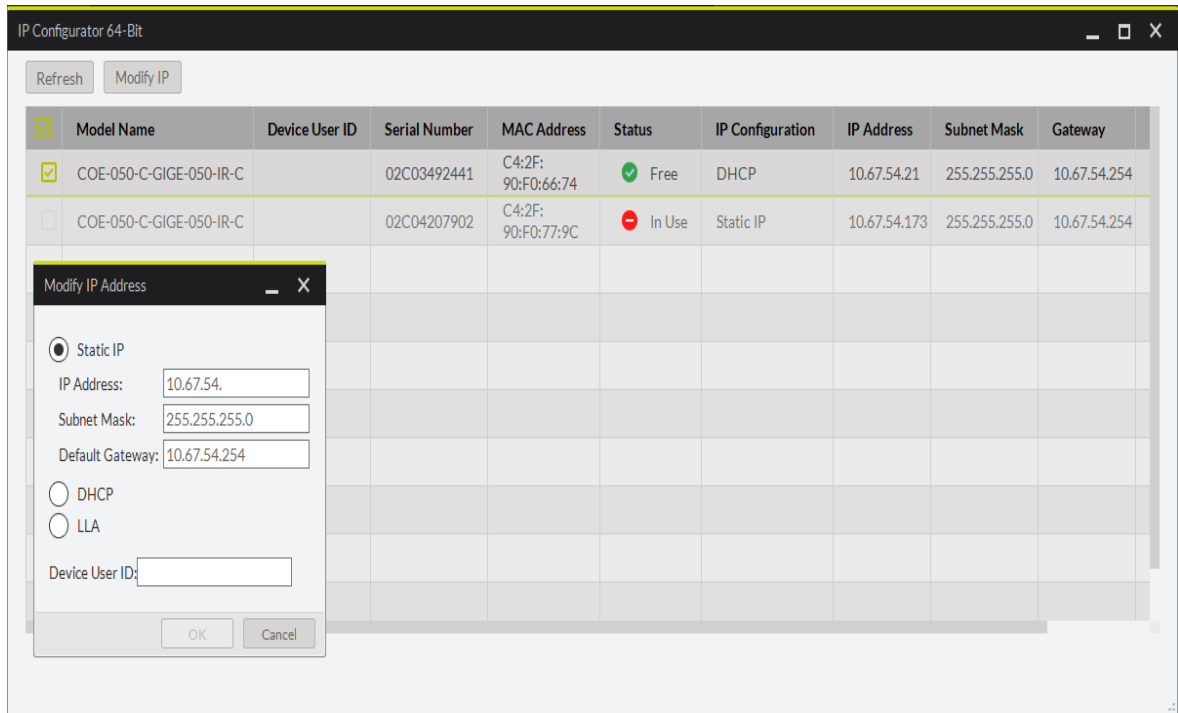

Figure 2-2 Camera Network Parameters Setting (1)

3. You can view the camera status and modify the settings.
  - If the camera status is Free, the camera is available and you can edit its IP address.
  - If the camera status is In Use, it means the client software or other processes are accessing the camera. You need to stop the live view and disconnect the camera, or terminate other processes to access the camera.
  - If the camera status is Not Reachable, the network of the camera is exceptional and you should check the camera network settings.

**Note:**

The camera status may be **In Use** if the camera IP address is conflicted with other devices. Please make sure the IP address is not busy before setting the camera IP address.

4. If the camera status is Free, you can edit its IP address.
  - 1) Select the IP type as Static IP, DHCP, or LLA.

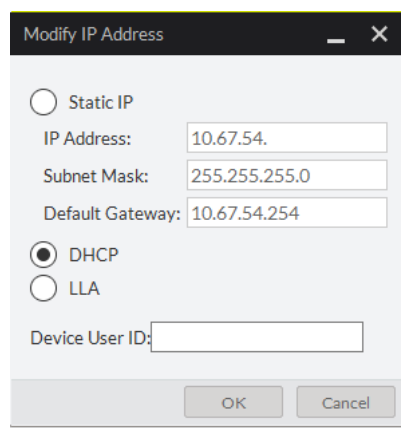



Figure 2-3 Camera Network Parameters Setting (2)

If you set the IP type as Static IP, you can set the IP address, subnet mask, and default gateway. You can also edit the the camera name in Device User ID field. Click Save to save the settings.

- 2) Select the camera to be edited and click  button.
- 3) In the pop-up window, you can edit the IP address of the camera. For Static IP type, you can also edit the subnet mask and default gateway.

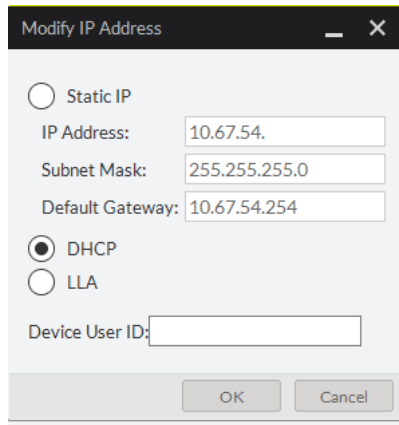

Figure 2-4 Camera Network Parameters Setting (3)

- 4) Click **OK** to save the settings.

## 2.3 Camera Configuration

### 2.3.1 Setting via Attribute Tree

The software can read the XML file of camera attributes and display it in tree format. Steps:

1. Double click the OECS icon to open the client software. The main user interface and the description of the client software are shown in Figure 2-5 and Table 2-1.

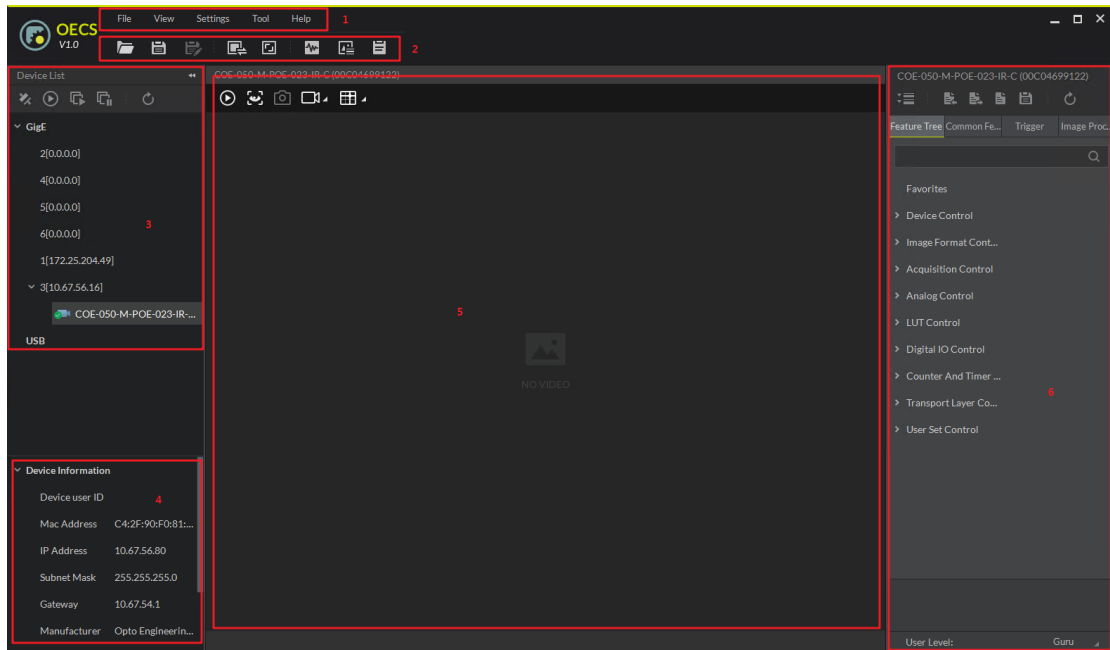

Figure 2-5 Main User Interface of the Client Software

Table 2-1 Description of the Main User Interface

No.	Area Name	Description
1	Menu Bar	Function modules including File, View, Camera, Settings, Tools, and Help.
2	Control Toolbar	The control toolbar.
3	Device List Panel	Display the GigE Vision camera and USB3 Vision camera, and provide icons for connecting/disconnecting camera, start/stop acquisition, and refreshing device list.
4	Interface and Device Information Panel	Display the network interface information and the device information.
5	Live View Area	View the live video of the selected COE camera.
6	Feature Panel	View and configure features of the selected camera, and perform other operations such as importing, exporting, and saving features.

**Note:**

For detailed information, refer the *User Manual of OECS Control Client*.

2. Double click the camera in Device List Panel.
3. Click the **Feature Tree** tab to enter the camera attribute page..

**Note:**

You can switch the user level as Beginner, Expert or Guru which displays different camera attributes. For Guru Level, it provides the most comprehensive camera attributes for professional use. Here we take Guru Level as an example.

4. Click the  icon before each attribute to view and edit the details.

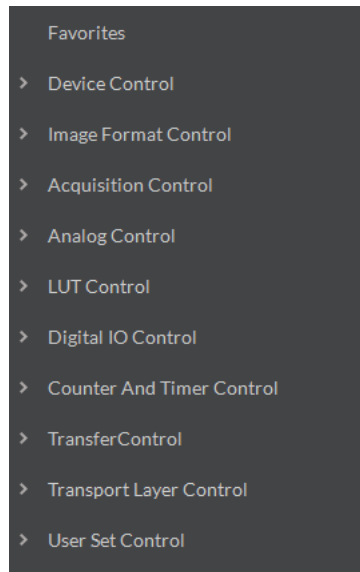

Figure 2-6 Attribute Page

- Device Control: In the Device Control attribute, you can view the camera details include device type, version, manufacturer details, device ID, device alias, device temperature, etc. You can modify the alias and reset the device.
- Image Format Control: In the Image Format Control attribute, you can view the live view image width and height, pixel size, etc. You can modify the image reverse status, test pattern and the embedded information, etc.
- Acquisition Control: In the Acquisition Control attribute, you can set the trigger mode, trigger source, exposure details, etc.
- Analog Control: In the Analog Control attribute, you can adjust analog gain, black level, brightness, gamma, sharpness, AOI, etc.
- LUT Control: In the LUT Control attribute, you can view the user lookup table and set the LUT index and value.
- Digital IO Control: In the Digital IO Control attribute, you can manage the digital input and output.
- Counter and Timer Control: In the Counter and Timer Control attribute, you can set the counter and timer function. It can count the triggering signal and control the exposure according to the user needs.
- Transport Layer Control: In the Transport Layer Control attribute, you can set the parameters of transport layer of the camera.
- User Set Control: In the User Set Control attribute, you can save or load the parameter configuration set by users. You can set the default parameter when running the software.

**Note:**

Functions and Attributes of COE cameras may be different among different camera models.

## Chapter 3 Functions

### 3.1 Device Control

#### 3.1.1 Name Modification

Run client software and click Device Control. You will see the device type, the version information, the device serial number and so on. Input the device name in Device User ID as shown in Figure 3-1.

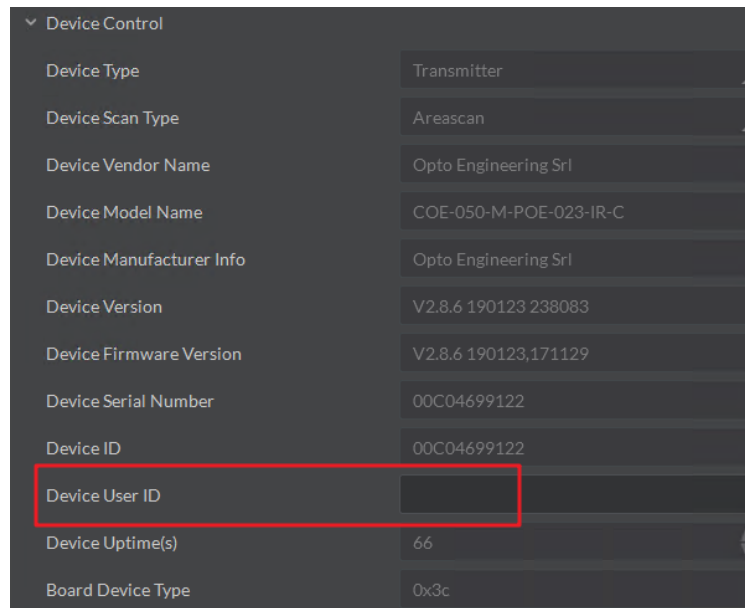

Figure 3-1 Device Name Modification

You can turn on the heartbeat detection mechanism, reset the device and view the device temperature in Device Control, as shown in Figure 3-2.

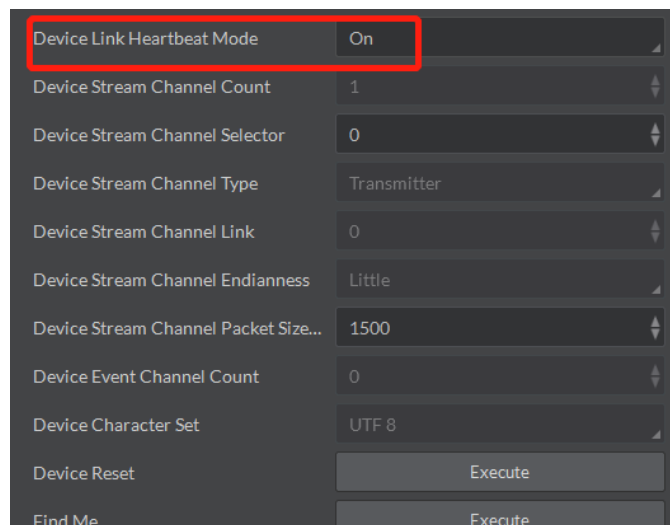

Figure 3-2 Device Information



### 3.2 Image Format and Frame Rate

Support different image format and customized ROI setting. The specified ROI will increase the image frame rate in some models.

**Note:**

The following figures are for reference only. The actual format depends on the camera’s supported formats.

#### 3.2.1 Camera Data Format

Color camera changes from the original data to RGB8 by color interpolation algorithm. Bayer GB, Bayer GR and any other patterns are shown in the following four figures.



Figure 3-3 Bayer GR Pixel Pattern

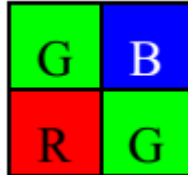

Figure 3-4 Bayer GB Pixel Pattern

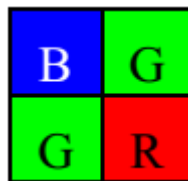

Figure 3-5 Bayer BG Pixel Pattern

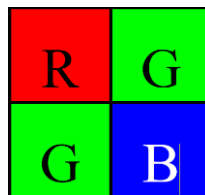

Figure 3-6 Bayer RG Pixel Pattern

The camera uses 12 bit ADC (some only support 10 bit ADC). Support 8 bit data output according to your

data processing capacity.

The camera will capture 8 bit from Most Significant Bits just as MSB8 output, in order to maintain the grey level output of the image data.

The bytes number corresponding to different formats are shown in Table 3-1.

Table 3-1 Pixel Format

Pixel Format	Byte Number
Mono 8, Bayer GB/GR/BG/RG 8	1
Bayer GR/GB/RG 12 Packed, Bayer BG/GR/RG 10 Packed, Mono10 Packed, Mono12 packed	1.5
Bayer GR/GB/RG 12, Bayer BG/GR/RG 10, YUV 4:2:2 (YUYV), YUV4:2:2 (YUYV) Packed	2
RGB 8	3

Click Image Format Control in the attribute list and select Pixel Format. You will find the supported pixel format. Choose the appropriate data output format as shown in Figure 3-7 and finish setting.

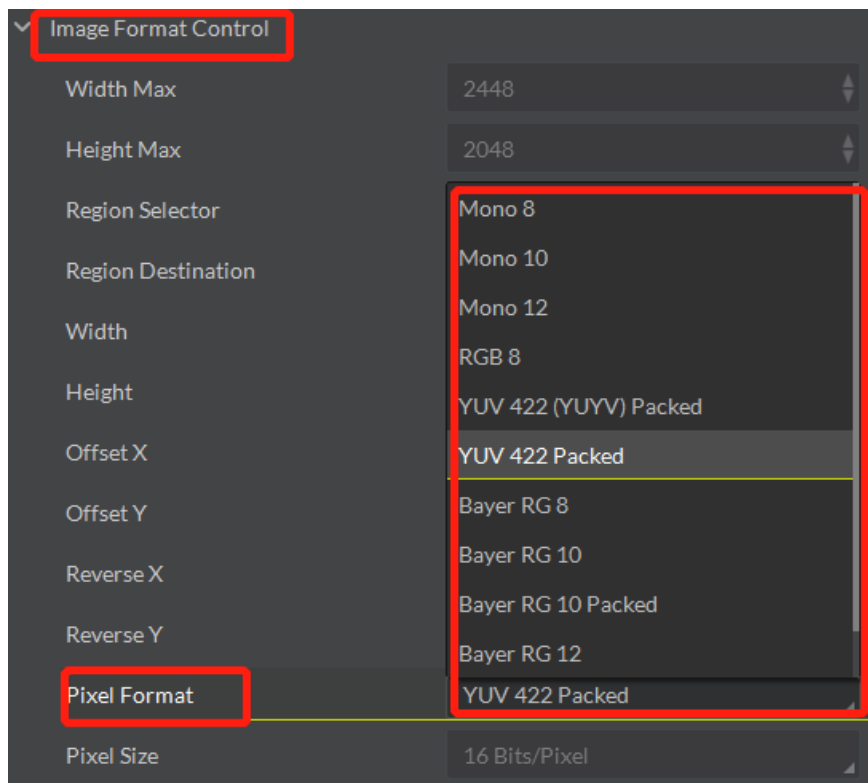

Figure 3-7 Frame Rate Setting

### 3.2.2 Frame Rate

The network transmission bandwidth, pixel format and output ROI resolution decides the maximum camera frame rate. Please refer to the frame rate formula when setting ROI.

Click Acquisition Control in the attribute list and select Acquisition Frame Rate. Input available frame rate as shown in Figure 3-8 and finish setting.

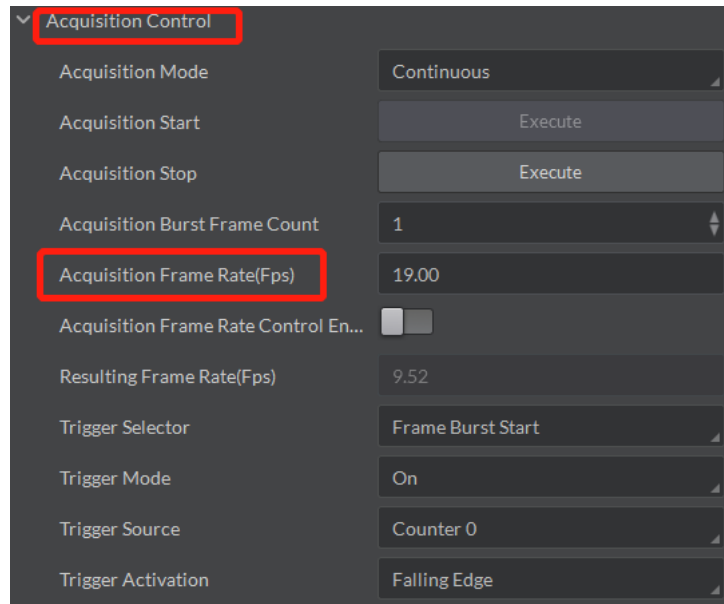

Figure 3-8 Frame Rate Setting

The lowest frame rate within the three formulas is Resulting Frame Rate.

Click Image Format Control and move. Select Width and Height. Adjust the ROI on the right side. The value in the Offset X and the Offset Y refer to the ROI starting point at the top left corner. The following figure shows the ROI setting.

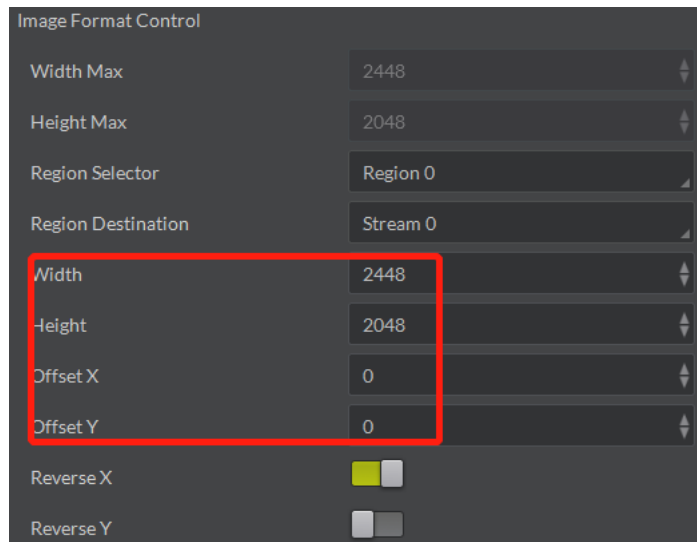

Figure 3-9 ROI Setting

**Note:**

For more information about bandwidth and Payload Size, please see the chapter of Transmission Layer Control.

### 3.3 Global Shutter and Rolling Shutter

#### 3.3.1 Global Shutter

Support global shutter camera. Exposure starts and ends in each line simultaneously. Data readout is after the exposure. The time for the sensor collecting exposure and for the data readout are the same, but as shown in Figure 3-10, different in the actual readout time.

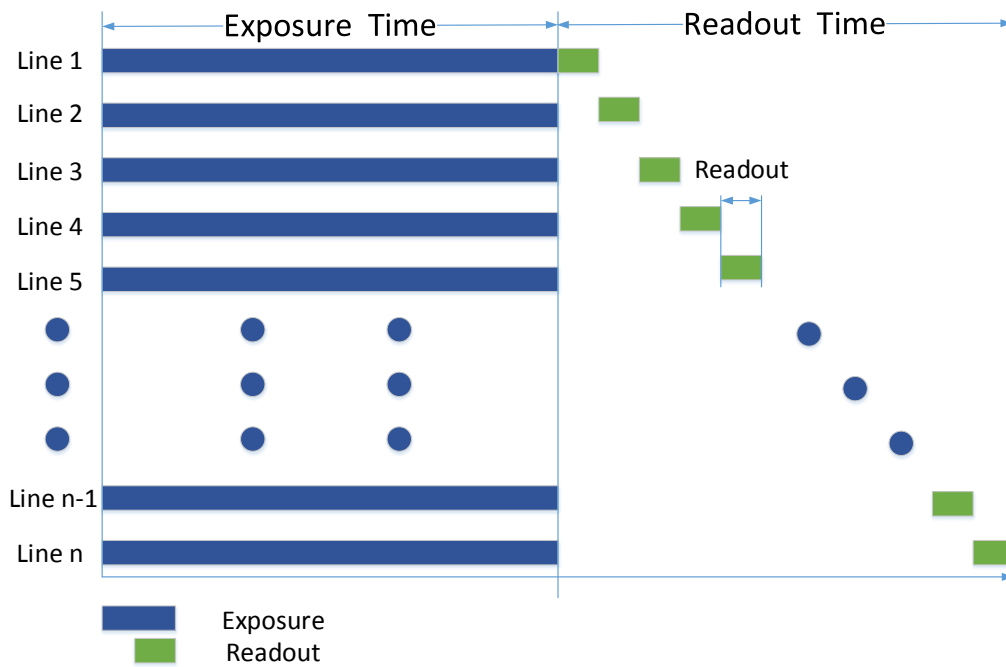

Figure 3-10 Global Shutter

#### 3.3.2 Rolling Shutter

Support rolling shutter camera. The exposure starts in the first row, and the data will read out simultaneously. After the whole action, the rest of rows start to expose and read out one by one. The time for the sensor collecting exposure and for the data readout are the same, but as shown in Figure 3-11, different in the exposure starting time.

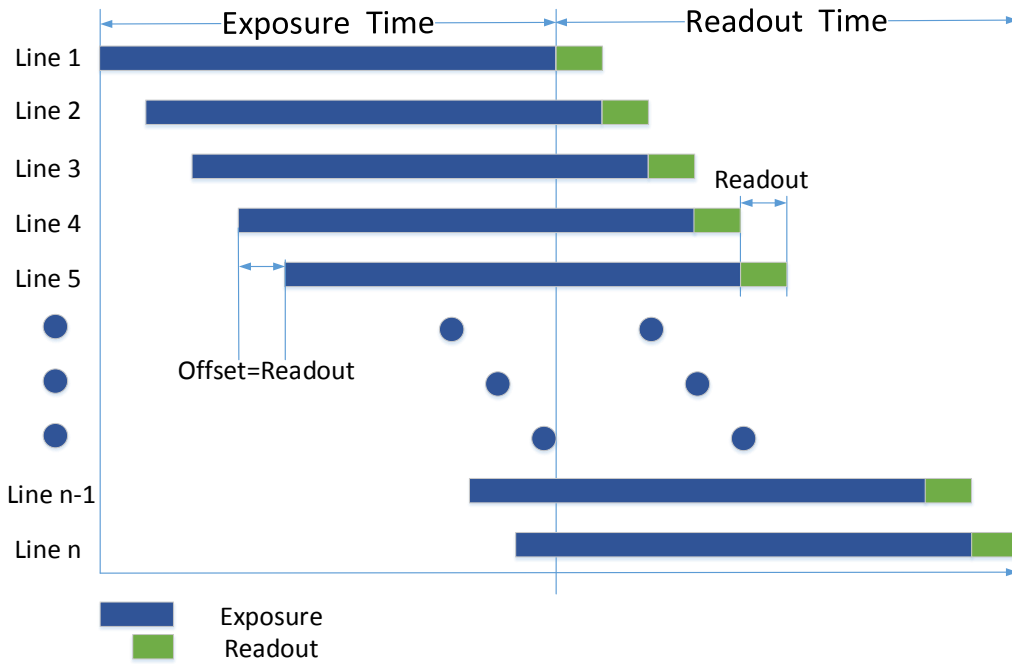

Figure 3-11 Rolling Shutter

- The figure of rolling shutter's signal readout under internal trigger mode

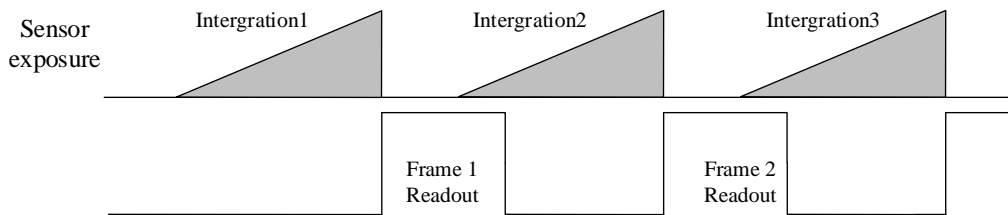

Figure 3-12 Internal Trigger Mode

- The figure of rolling shutter's signal readout under the external trigger mode

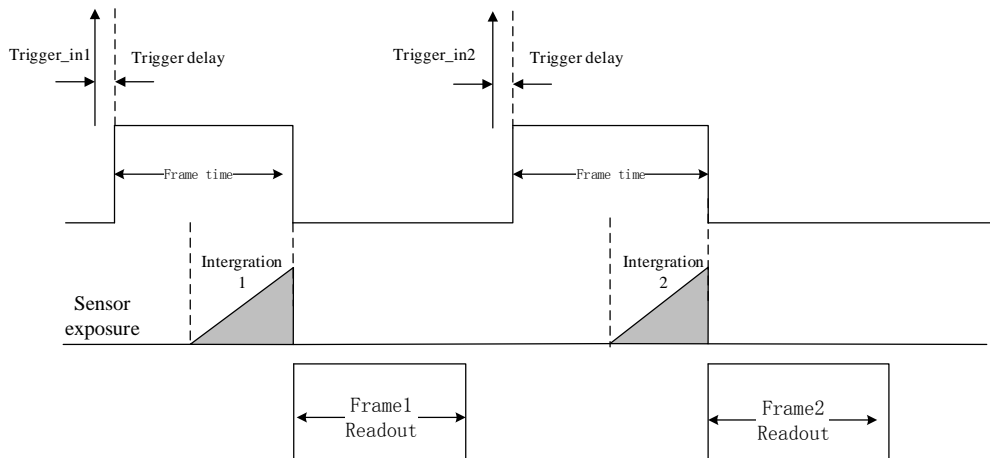

Figure 3-13 External Trigger Mode

### 3.4 Image Acquisition and Transmission

Image acquisition mode is divided into internal trigger mode and external trigger mode. Internal trigger mode includes continuous acquisition mode and single frame acquisition mode. External trigger mode includes software trigger mode and hardware external trigger mode.

Select On or Off in Trigger Mode to select either internal trigger mode or external trigger mode. (Off refers to the internal trigger mode and On refers to the external trigger mode.)

#### 3.4.1 Internal Trigger Mode

The Camera can output one image or several images continuously in the internal trigger mode.

Click Acquisition Control in the attribute list. Select Acquisition Mode and you will see elements of Continuous and SingleFrame. Continuous refers to outputting images continuously based on the configured frame rate. SingleFrame refers to outputting only one image, as shown in Figure 3-14.

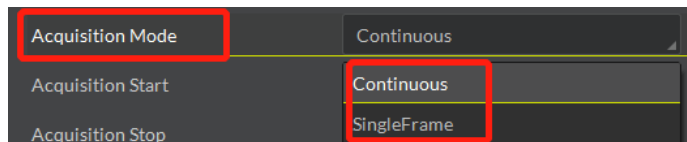

Figure 3-14 Internal Trigger Mode

#### 3.4.2 External Trigger Signal and Working Mode

The signal for the camera to acquire external trigger signal includes the software trigger signal and the signal from external level.

Under the external trigger signal mode, the camera can output images according to single frame mode, burst mode, PWM mode and any other working modes.

- Software trigger mode

Support software trigger mode. When setting software trigger mode, the client software will send command to the camera to capture and transfer images by gigabit network.

Click Acquisition Control in the attribute list and select Trigger Mode. Choose On to open trigger mode. Select Trigger Source and choose Software to switch to the software external trigger status. Click Execute in Trigger Software to trigger image acquisition, as shown in Figure 3-15.

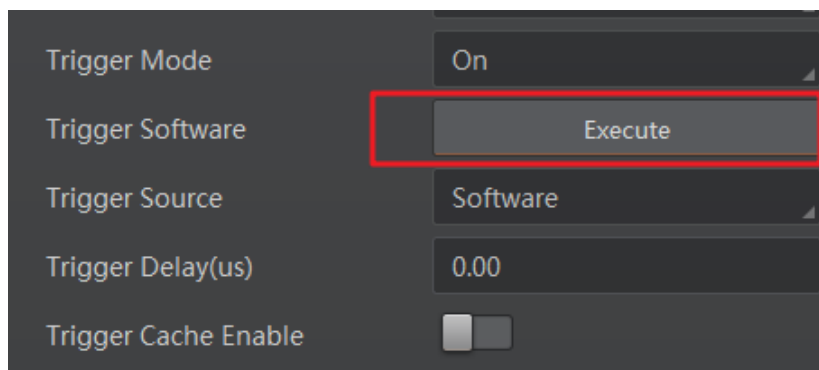

Figure 3-15 Software Trigger Mode Setting

- Hardware external trigger mode

Select Trigger Source and Choose Hardware to switch to the hardware external trigger status.

Available parameter setting of input signal from hardware external trigger:

(1) Trigger edge selection

Selecting Rising Edge/Falling Edge under the external signal is available.

(2) Trigger delay

As shown in Figure 3-16, in order to integrate later, the camera can set delay time when receiving the trigger signal. As shown in Figure 3-17, the delay time can be set through Trigger Delay. The range is from 0 to 32000000 and the unit is  $\mu s$ .

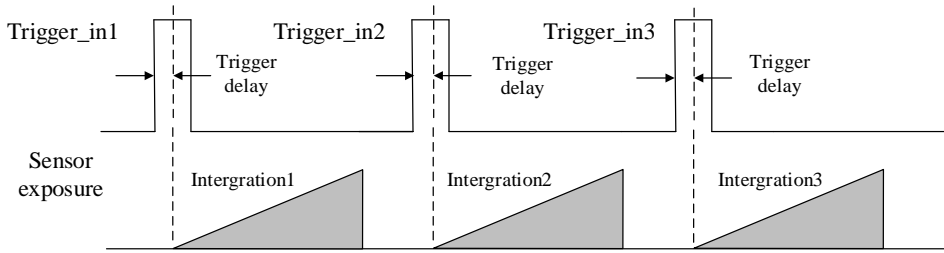

Figure 3-16 Signal Delay Principle

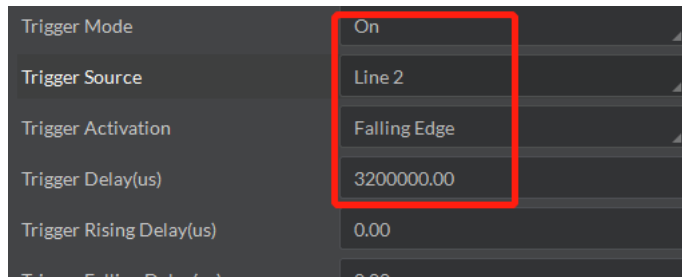

Figure 3-17 Delay Time Setting

(3) Triggering Anti-jitter

The noise may exist in external trigger's input signal and it may cause spurious triggering status if it goes into the camera. Thus the debounce is necessary.

The debounce parameter can be set through Line Debouncer Time in the client software. The unit is  $\mu s$ . The timing sequence map is shown in Figure 3-18. The camera will ignore the trigger signal if the debouncer time is longer than the triggering signal time.

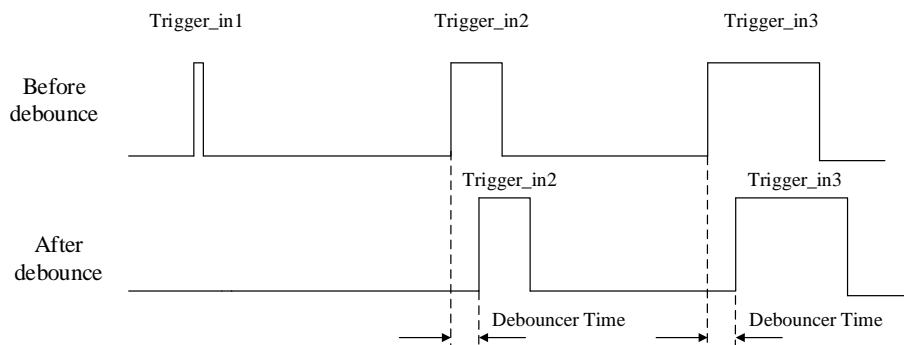

Figure 3-18 The Debounce of Triggering Input Signal Sequence Map

### 3.5 Strobe Output

Strobe is external trigger output signal and is used for controlling external devices such as flashing light and so on. You can set the Strobe polarity, duration, output delay and pre-trigger through the client software.

As shown in Figure 3-19, click Digital IO Control. Select Line Selector and choose output pin. Check Strobe Enabled and finish setting.

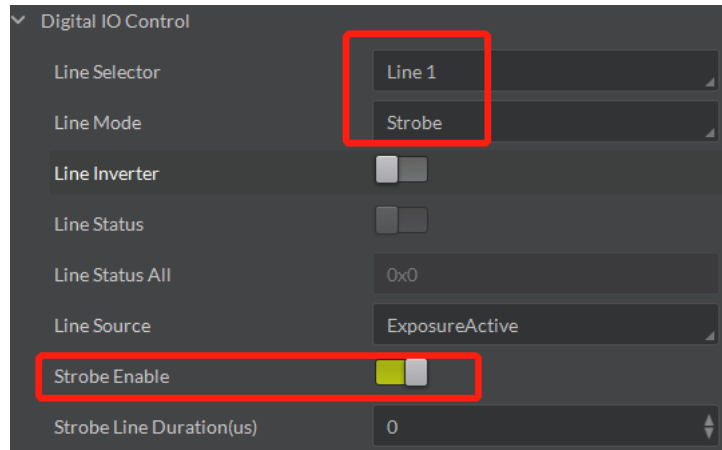

Figure 3-19 Strobe Output Mode

Available Strobe parameter setting:

- (1) Polarity setting

Tick Line Inverter to set polarity external trigger’s output signal, as shown in Figure 3-20.

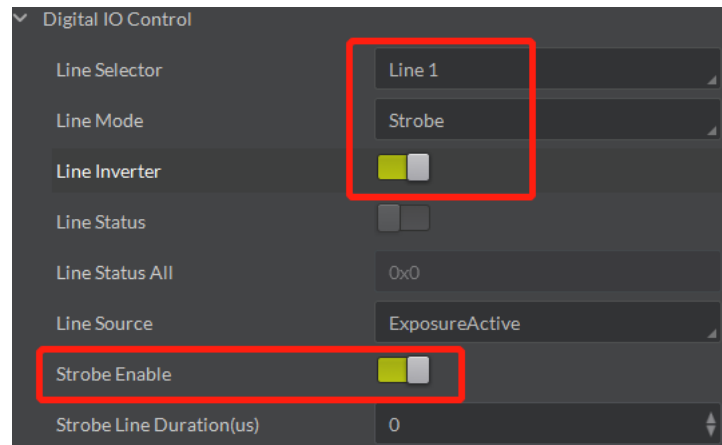

Figure 3-20 Modifying Strobe Polarity

- (2) Strobe valid time

As shown in Figure 3-21, Strobe is set to high level. When exposure starts, Strobe will output immediately. Strobe Line Duration value decides the Strobe duration: when the Strobe Line Duration value is 0, the Strobe duration is equal to the exposure time; when the Strobe Line Duration value is not 0, the Strobe duration is equal to Strobe Line Duration value.



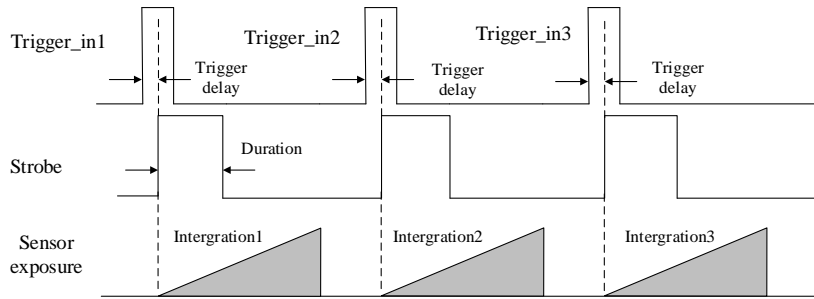

Figure 3-21 Strobe Valid Electrical Level Duration

(3) Strobe output delay

The camera supports the function of Strobe signal output delay to satisfy special applications: as shown in Figure 3-22, when exposure starts, the Strobe output is not valid immediately. Instead, the Strobe output will delay according to the setting in Strobe Line Delay.

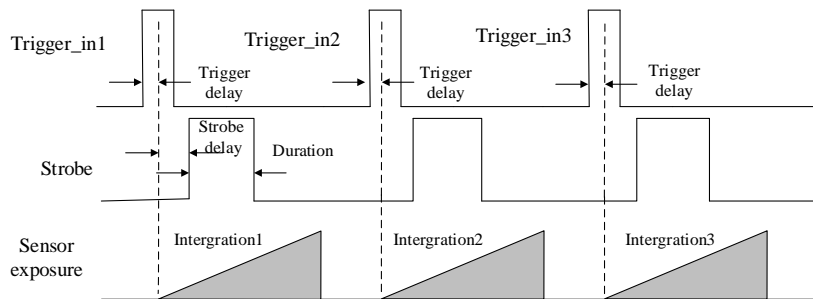

Figure 3-22 Strobe Output Delay Sequence Map

(4) Strobe pre-trigger

Support Strobe pre-trigger. Strobe signal is valid before the sensor exposure. This function can apply to the LED light that takes time to be stable after starting. It is necessary for a stable light source when capturing images. Pre-trigger time can be set through Strobe Line Pre Delay in the client as shown in Figure 3-23.

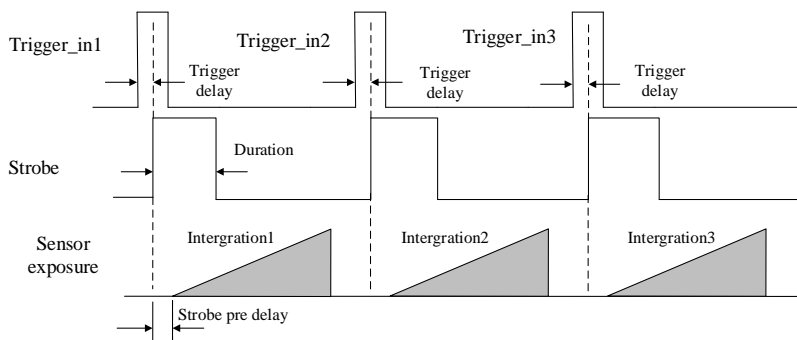

Figure 3-23 Strobe Pre-trigger Sequence Map

### 3.6 Acquisition Mode under External Trigger

The acquisition mode under external trigger includes single frame mode, burst mode and PWM mode. The relationship among the input trigger signal, the Strobe output signal, the exposure time and readout time under different modes is as follows:

(1) Single frame mode

Expose only once when inputting one trigger signal.

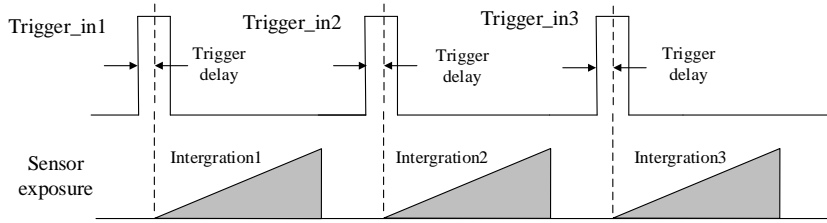

Figure 3-24 Single Frame Mode

The frame rate and exposure time decide to trigger the next frame or not when reading out camera data. If exposure is in progress, the camera will ignore another external trigger signal. You can set a longer exposure time to achieve Bulb Shutter.

(2) Burst mode

The camera supports burst mode: receiving one trigger signal and outputting multiply frames images. You can set the burst number by Acquisition Burst Frame Count in the client software. The range is from 0 to 1023. The sequence map is shown in Figure 3-25. If Burst Frame Count = 3, one trigger signal will output three frames images and at the same time output three strobe signals.

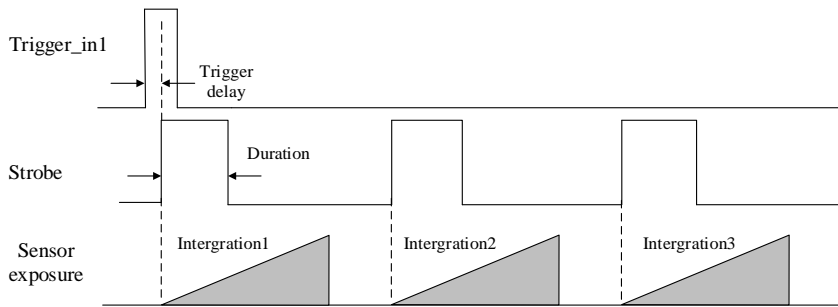

Figure 3-25 Burst Mode Sequence Map

(3) PWM mode

Support PWM mode. The difference in the sensor's exposure time is the main difference between the PWM mode and the single frame mode. In the PWM mode, the duration of trigger source decides the sensor's exposure time of each frame. The sequence map is shown in Figure 3-26.

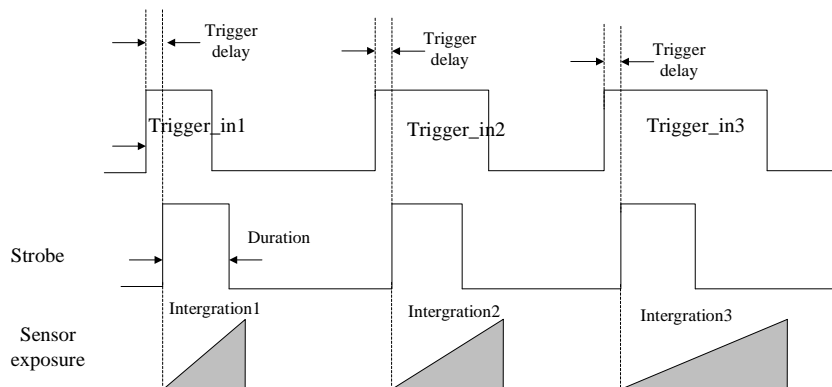

Figure 3-26 PWM Mode Sequence Map

### 3.7 Overlap Exposure and Non-overlap Exposure

To capture one frame of image includes the exposure and the readout. According to the overlap relationship between the exposure time and the readout time, cameras with different chips can be divided into overlap exposure and non-overlap exposure.

#### 3.7.1 Non-overlap Exposure

After completing the current frame's exposure and readout, the next frame starts to expose and read out. This process is called non-overlap exposure. The non-overlap exposure's frame period is larger than the sum of the exposure time and the readout time as shown in Figure 3-27 and Figure 3-28.

- Non-overlap exposure under internal trigger mode

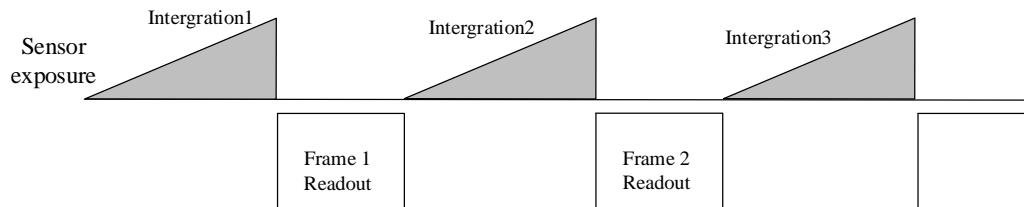

Figure 3-27 Internal Non-overlap Exposure

- Non-overlap exposure under external trigger mode

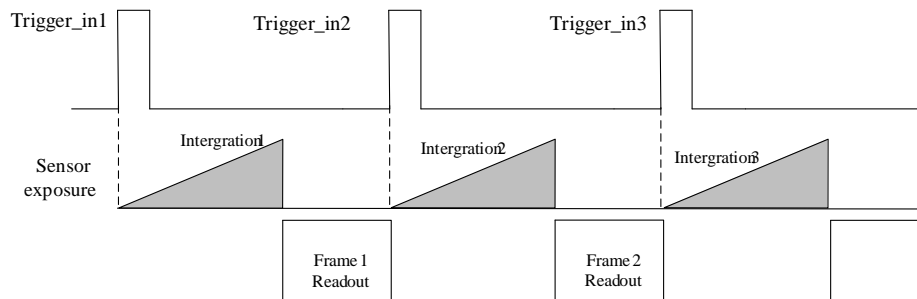

Figure 3-28 External Non-overlap Exposure

The camera will ignore the receiving external signal in the readout section under this mode.

#### 3.7.2 Overlap Exposure

Overlap exposure refers to the overlap between the current frame exposure and the last frame readout. In other words, when the last frame starts to read out, the current frame starts to expose simultaneously.

- Overlap exposure under internal trigger mode

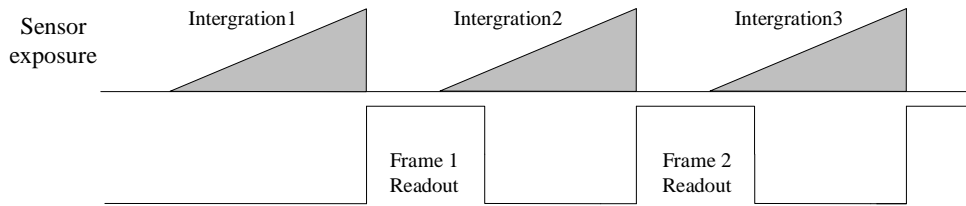

Figure 3-29 Internal Trigger Overlap Exposure

- Overlap exposure under external trigger mode

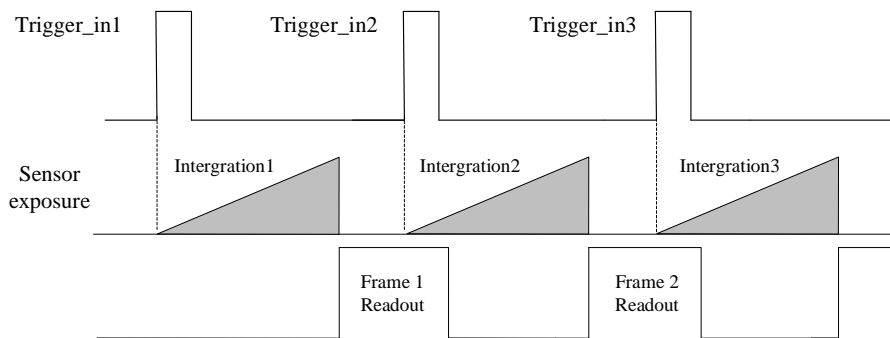

Figure 3-30 External Trigger Overlap Exposure

### 3.8 Counter Control

The counter can divide frequencies that from external inputting trigger signal. You can control the exposure depends on your expectations. Operation steps are as follows:

As shown in Figure 3-31, click Acquisition Burst Frame Count and select Trigger Source. Choose Counter 0.

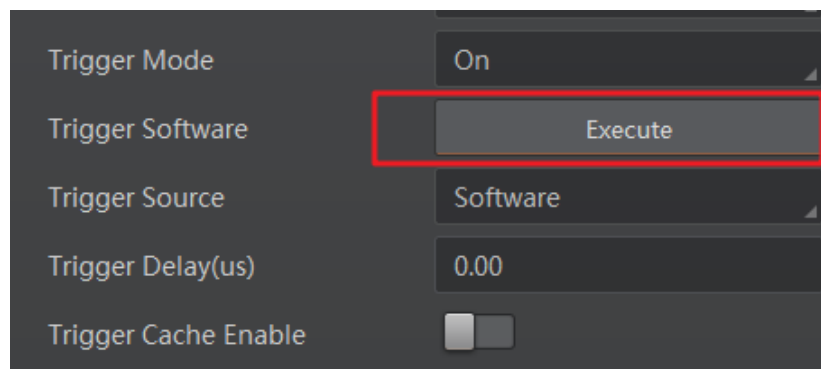

Figure 3-31 Trigger Source Configuration

As shown in Figure 3-32, click Counter And Timer Control and select external trigger source which needs frequency division.

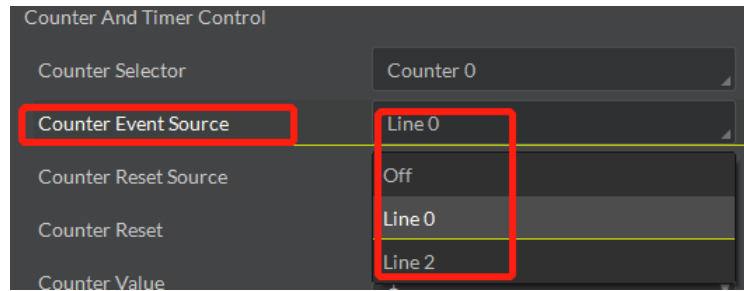

Figure 3-32 Counter Frequency Division Configuration

**Note:**

By default, Line 0 is signal input pin. Line 2 is configurable input and output pin. Configure Line 2 to input pin in Digital IO Control, as shown in Figure 3-33, in order to do frequency division for Line 2.

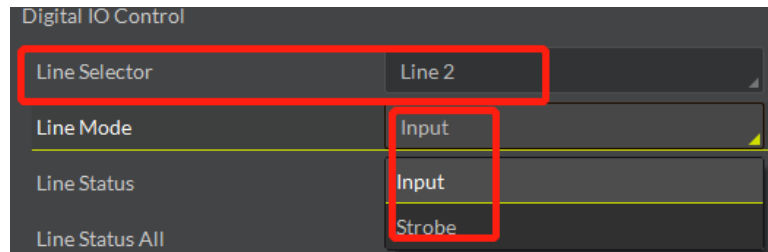

Figure 3-33 Configuring Line 2 Pin to Input

In Counter And Timer Control, you should set Counter Value. Parameter value range is from 1 to 1023. Please see the red 2 in Figure 3-34.

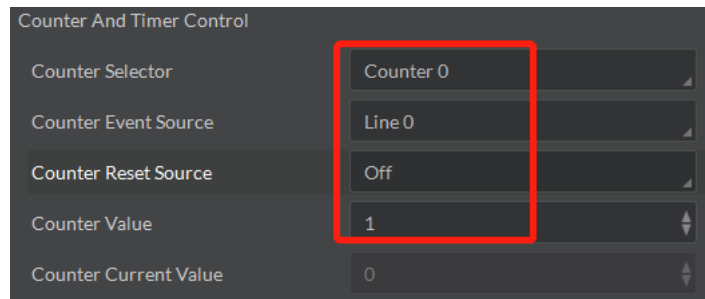

Figure 3-34 Counter Parameter Setting

By default, Counter Reset Source is OFF as shown in the red 1 in Figure 3-34. Click Counter And Timer Control and select Counter Reset Source. Choose Software and click Execute to reset the counter, as shown in Figure 3-35.

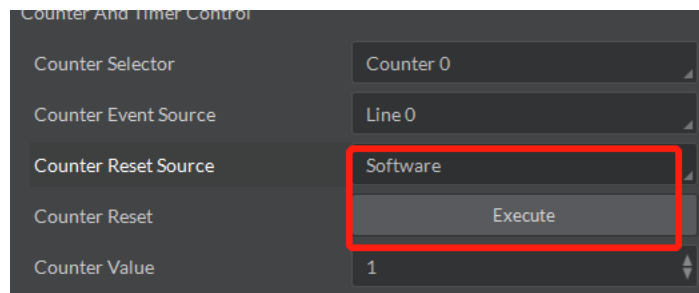

Figure 3-35 Resetting The Counter

### 3.9 Imaging Parameter Setting

#### 3.9.1 Exposure Time

Please refer to the camera technical index to acquire the supported exposure time. The exposure control supports manual mode, single mode and continuous mode. When setting trigger mode, the single mode and continuous mode are invalid. When setting single mode or continuous mode, the exposure time will be limited by Auto Exposure Time Lower Limit and Auto Exposure Time Upper Limit. The time range should only be set between Auto Exposure Time Lower Limit and Auto Exposure Time Upper Limit.

Click Acquisition Control in the attribute list. Select Auto Exposure Time Lower Limit and Auto Exposure Time Upper Limit. Input available parameter to the numeric field. Set the running parameter range of the auto exposure time, as shown in Figure 3-36.

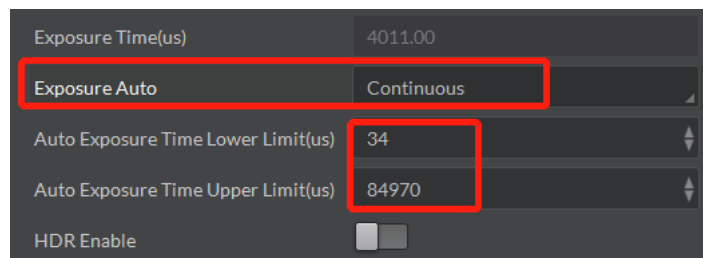

Figure 3-36 Exposure Control

#### 3.9.2 Gain Control

Please refer to the camera technical index to acquire the supported Gain Value. Gain Control supports manual mode, single mode and continuous mode. Gain Control under these three modes can be shown as follows:

**Manual mode:** Set Gain according to the user’s setting value.

**Single mode:** Set Gain value automatically according to the target image brightness. Set once only.

**Continuous mode:** Adjusting Gain continuously according to the target image brightness.

When setting single mode or continuous mode, Gain is limited by Auto Gain Lower Limit and Auto Gain Upper Limit. Gain Range should only be set between Auto Gain Lower Limit and Auto Gain Upper Limit.

Click Analog Control in the attribute list. Click Gain Auto. Select Gain Mode. Input available parameter in the numeric field and finish setting, as shown in Figure 3-37.

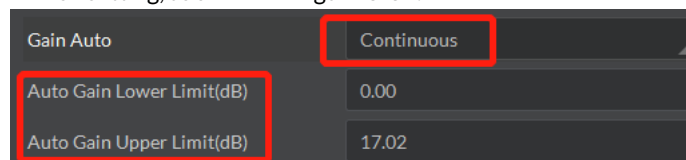

Figure 3-37 Gain Control

The noise increases when Gain increases. Auto exposure and Auto Gain are mutually restricted. When the image is dark, the camera will firstly increase the exposure time. Secondly, the camera starts to adjust Gain Value when the exposure time turns to the maximum. When the image is bright, the camera will firstly decrease Gain Value. Secondly, it starts to adjust the exposure time when Gain Value turns to the

minimum.

### 3.9.3 White balance

The camera supports the white balance. The white balance refers to the camera color adjustment depending on different light sources. Adjust the Gain Value of the image's R channel and B channel to keep white regions white under different color temperatures. Ideally, the proportion of R channel, G channel and B channel in the white region is 1:1:1.

Table 3-2 White Balance Status Introduction

Status	Description
OFF	MBW mode: You can adjust the R, G, and B gain value manually. The adjustable range is 1 to 4095, 1024 means the ratio is 1.0.
ONCE	Adjust the white balance value according to the current scene and the adjustment stops automatically after a while. The adjustment adopts a algorithm that looks for the gray blocks in the Bayer data.

**Note:**

The white balance adjustment is only available in color models.

Click Analog Control in the attribute list. Click Balance White Auto and Balance Ratio Selector. Select available white balance status parameter and finish setting, as shown in Figure 3-38.

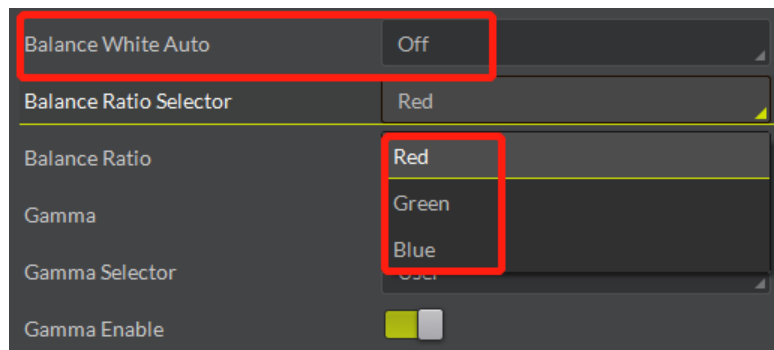

Figure 3-38 White Balance Setting

### 3.9.4 Region Setting of Auto Functions

The camera can adjust exposure time and white balance automatically to achieve your expectations. By default, the camera will adjust the brightness and the white balance of the whole image. In addition, you can also set an area of interest, which is called AOI. The camera will adjust the AOI in the image. And the area outside the selected region will also be changed.

Regional exposure and regional white balance are generally used in the back light scene and the scene with the great difference of regional brightness. You can also select rectangle region. The camera will adjust the region's exposure and white balance to achieve the best image quality.

Click Analog Control in the attribute list. Select Auto Function AOI Selector. Choose AOI1 or AOI2. Adjust Auto Function AOI Width value and Auto Function AOI Height value and finish setting, as shown in Figure 3-39.

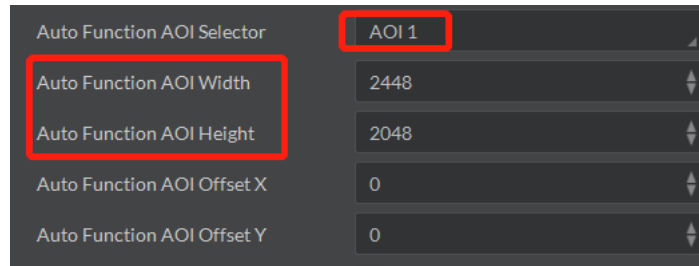

Figure 3-39 AOI Setting

**Note:**

The available exposure region and the white balance region are the overlapped part of the setting region and the image region. If there is no overlap, the available region refers to the whole image.

### 3.9.5 Look Up Table (LUT)

LUT is the grey level mapping table. You can change the grey level in your interested regions. The operation can be linearity curve or custom mapping curve. LUT and Gamma are mutually exclusive.

Set the user mode to Guru Mode. Click LUT Enable and adjust the parameters, as shown in Figure 3-40.

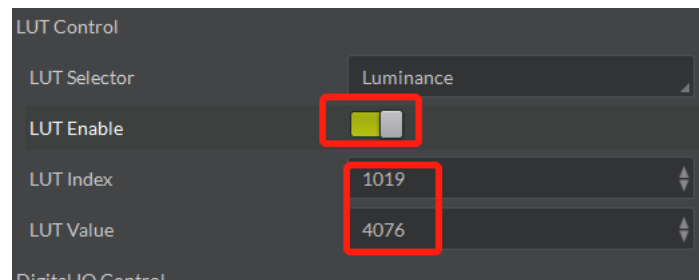

Figure 3-40 LUT Setting

### 3.9.6 Gamma Correction

The camera supports Gamma Correction. Normally, the output of the camera chip and the number of photon that the sensor (on the chip) received are linear. And Gamma Correction provides a non-linear output. If the Gamma value is between 0.5 and 1, the image brightness decreases while the brightness of the dark area increases. If the Gamma value is between 1 and 4, the image brightness increases while the brightness of the dark area decreases.



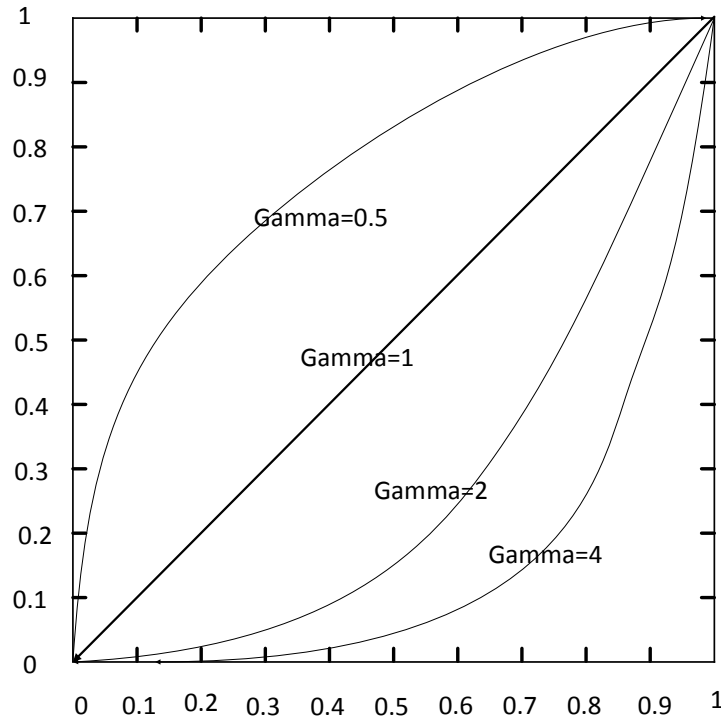

Figure 3-41 Gamma Curve

Click Analog Control in the attribute list. Select Gamma and Gamma Selector and set the parameter as shown in Figure 3-42.

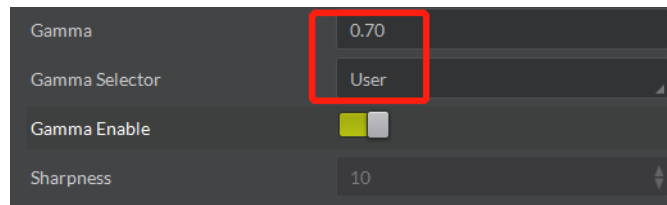

Figure 3-42 Gamma Setting

**Note:**

Different camera versions have different default function parameters. The figures shown above are only for reference.

**3.9.7 Brightness, Hue and Saturation**

- **Brightness**

You can adjust the brightness of the exposure target. The default value is 64. The larger the value, the brighter the image.

- **Hue**

You can adjust the hue value in HSV. The default value is 128.

- **Saturation**

You can adjust the saturation value in HSV. The default value is 128. The larger the value, the higher the saturation and the stronger the color.

**Note:**

The hue and the saturation are only for the color camera.

### 3.9.8 Image Reverse

The camera supports image horizontal mirroring. Open the mirroring function to gain the horizontal mirroring image. Click Image Format Control. Tick Reverse X (horizontal) or Reverse Y (vertical) according to your preference, as shown in Figure 3-43.

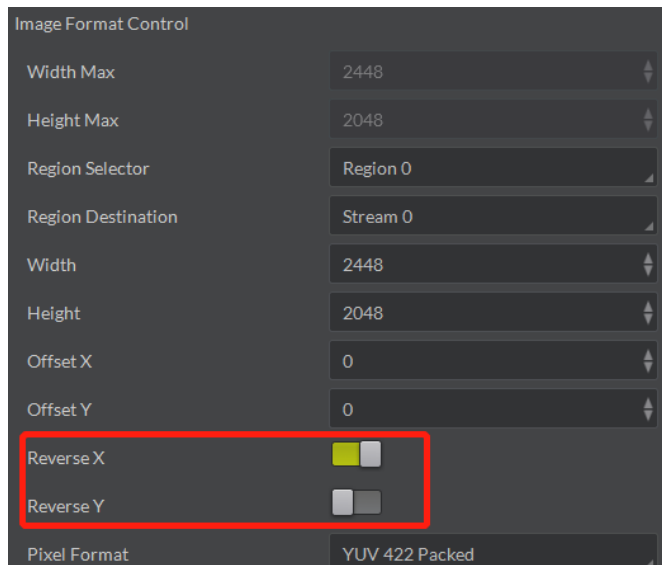

Figure 3-43 Tick Mirroring Function

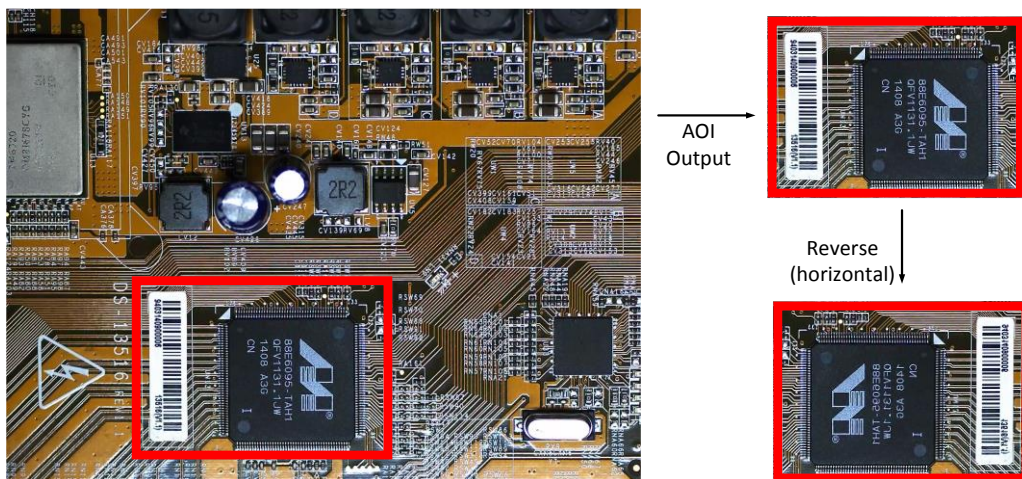

Figure 3-44 The Comparison of ROI Output Before And After Mirroring

### 3.9.9 HDR Cycling Mode

The camera supports HDR cycling mode: the camera can capture images in cycling mode depending on four groups of parameters. You can configure exposure time and Gain independently by setting

parameters in each group.

Click Acquisition Control and choose Selector. Set parameters in each group. Set available parameter in HDR Shutter and HDR Gain. Tick HDR Enable and finish setting, as shown in Figure 3-45.

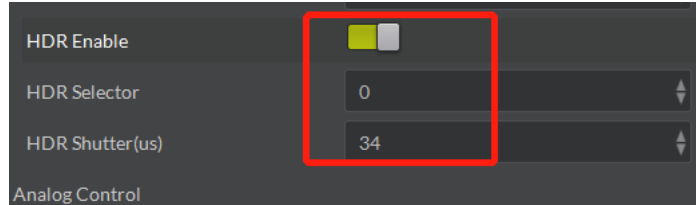

Figure 3-45 Four Groups of Parameters' HDR Cycling.

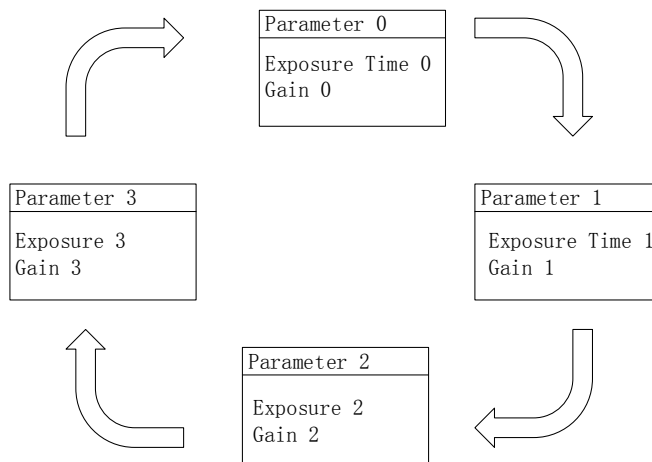

Figure 3-46 HDR Cycling Map

### 3.9.10 Test pattern

Click Image Format Control in the attribute list. Select Test Pattern and set the parameter. The default test pattern is OFF, as shown in Figure 3-47.

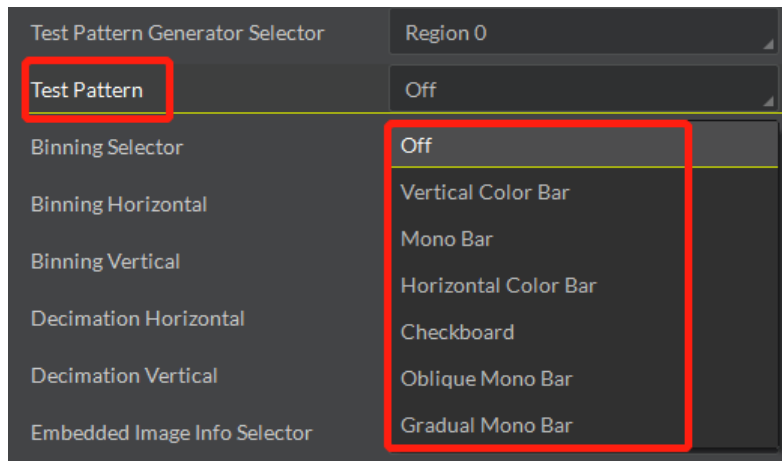

Figure 3-47 Test Pattern

The camera provides four test patterns, including Mono Bar, Vertical Color Bar, Horizontal Color Bar and Checkboard as shown in the following four figures.

**Note:** Color camera and black and white camera have different test patterns. The specific test pattern is decided by the camera function.

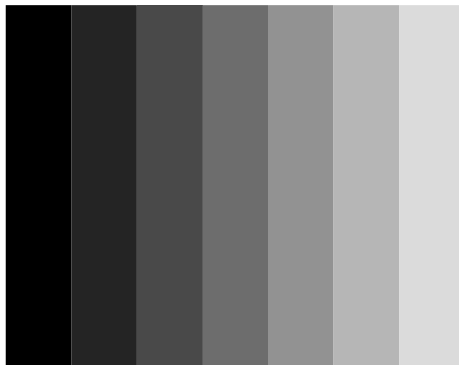

Figure 3-48 Mono Bar Test Pattern

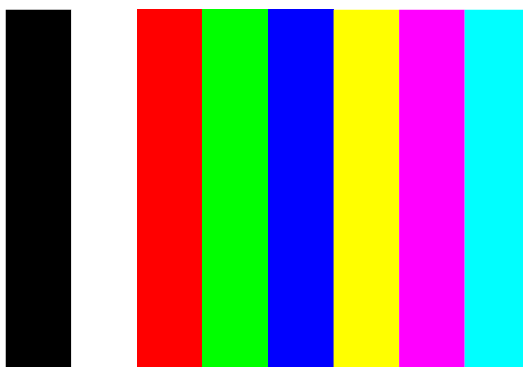

Figure 3-49 Vertical Color Bar Test Pattern



Figure 3-50 Horizontal Color Bar Test Pattern

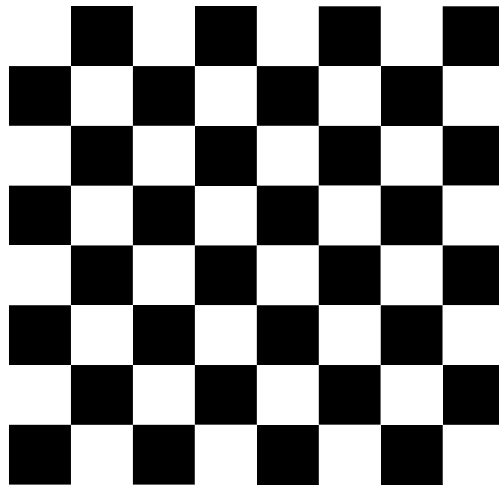

Figure 3-51 Checkboard Test Pattern

### 3.10 I/O Electric Feature

#### 3.10.1 Line0 Opto-isolated Input Circuit

In controlling camera I/O, Line0 input circuit can be shown in Figure 3-52.

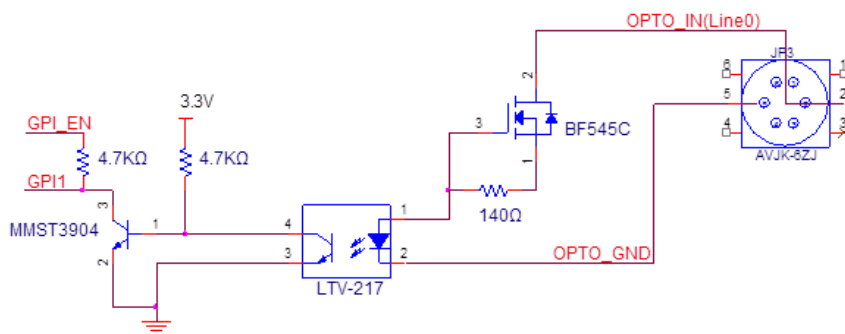

Figure 3-52 Input Circuit

Logic 0 input level: 0~1VDC (OPTO\_IN pin)

Logic 1 input level: 1.5~24VDC (OPTO\_IN pin)

Maximum input current: 25 mA

Please make sure the input voltage is not from 1V to 1.5V as the electric status among the two values is not stable.

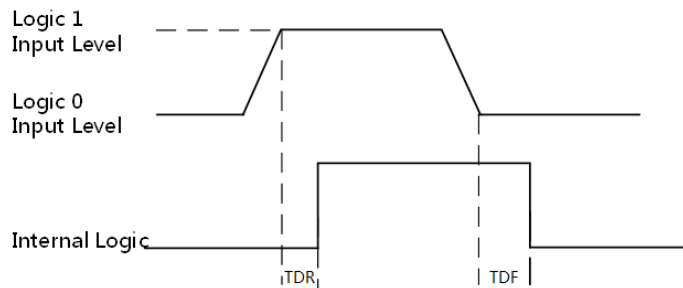

Figure 3-53 Input Logic Level

Input rising delay (TDR): 2.6μ s  
 Input falling delay (TDR): 19.2μ s

### 3.10.2 Line1 Opto-isolated Output Circuit

In controlling I/O, Line1 output circuit can be shown in Figure 3-54.

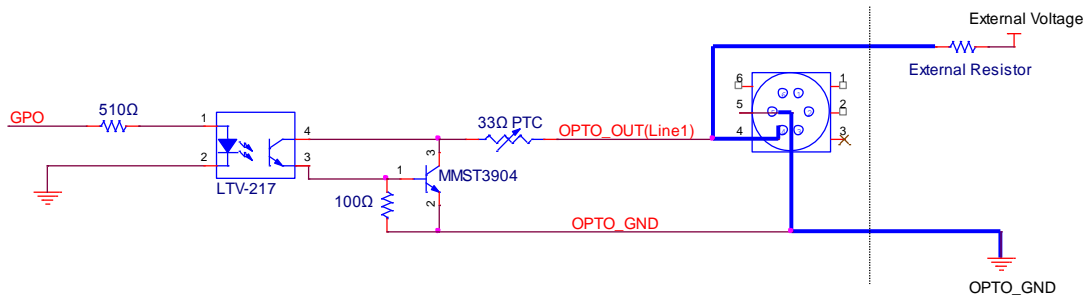

Figure 3-54 Output Circuit

Maximum Line1 output current: 25 mA

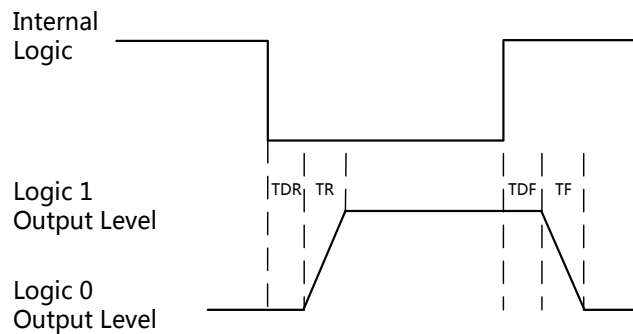

Figure 3-55 Output Logic Level

Opto-isolated output electric feature can be shown in Table 3-3 (The external voltage is 3.3 V and the external resistance is 1 K.)

Table 3-3 Output Electric Feature

Parameter	Symbol	Value
Output Logic Low Level	VL	575mV
Output Logic High Level	VH	3.3V
Output Rising Time	TR	8.4us
Output Falling Time	TF	1.9us
Output Rising Delay	TDR	16.6us
Output Falling Delay	TDF	3.6us

Table 3-6 shows the corresponding current and the parameter of output logic low level when the

opto-isolated outputs the different external voltage and resistance.

Table 3-4 The Parameter of Output Logic Low Level

External Voltage	External Resistor	VL	Output Current
3.3V	1KΩ	575mV	2.7mA
5V	1KΩ	840mV	4.1mA
12V	2.4KΩ	915mV	4.6mA
24V	4.7KΩ	975mV	4.9mA

### 3.10.3 Line2 Configurable Bi-direction I/O Circuit

In controlling I/O, the configurable bi-direction non-isolated IO circuit of Line2 can be shown in Figure 3-56.

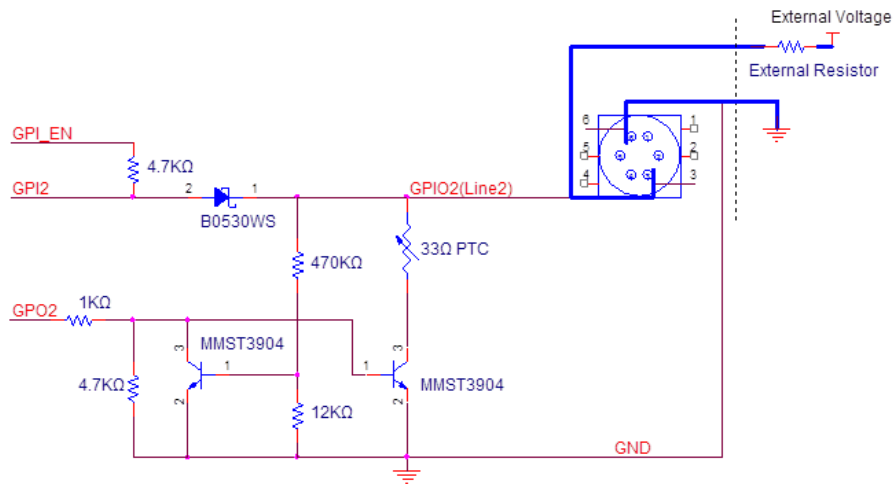

Figure 3-56 Line2 Bi-direction I/O Circuit

1. Configure Line2 to input pin

Logic 0 input level: 0~0.5VDC (GPIO2 pin)

Logic 1 input level: 1.5~30VDC (GPIO2 pin)

Please make sure the input voltage is not from 0.5V to 1.5V as the electric status among the two values is not stable.

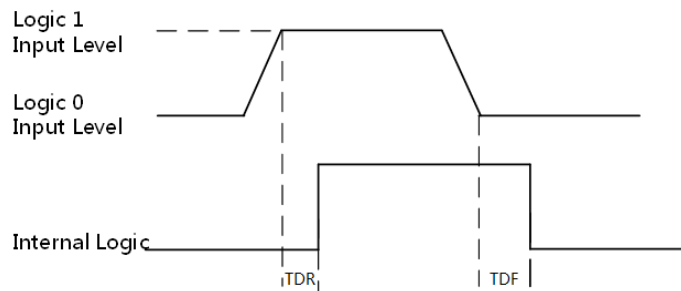

Figure 3-57 Inputting Logic Level

Please connect to GND pin first to protect GPIO pin and then input voltage to Line2 pin.

2. Configure Line2 to output pin

The available maximum current is 25mA and the output impedance is 40Ω .

When the environment temperature is 25 degree centigrade, the relationship among external voltage, impedance and the output low level can be shown in Table 3-5.

Table 3-5 The Parameter of Output Logic Low Level

External Voltage	External Resistor	VL (GPIO2)
3.3V	1KΩ	160mV
5V	1KΩ	220mV
12V	1KΩ	460mV
24V	1KΩ	860mV
30V	1KΩ	970mV

When the external voltage of 1KΩ external resistance turns to 5V, features of output logic level and electric feature in GPIO2 configuration can be shown in Figure 3-58 and Table 3-6.

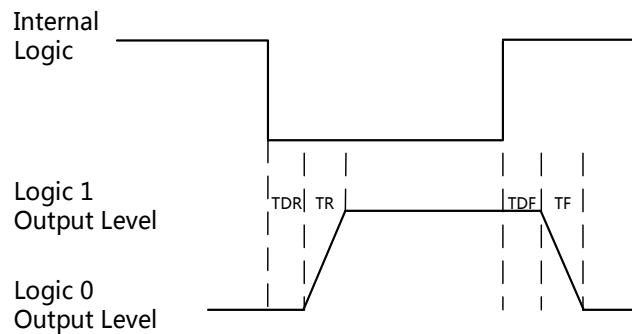

Figure 3-58 Output Logic Level

Table 3-6 Output Electric Feature

Parameter	Symbol	Value
Output Logic Low Level	TR	0.06us
Output Logic High Level	TF	0.016us
Output Rising Time	TDR	0.03us
Output Falling Time	TDF	0.28us

### 3.11 Transport Layer Control

#### 3.11.1 DHCP and Persistent IP

The camera supports connecting with PC through DHCP or Persistent IP. As shown in Figure 3-59, the camera will acquire IP according to the following order.



- (1) If the camera's Persistent IP is available and the configured Persistent IP is available, the camera will load this Persistent IP. Or execute (2).
- (2) If DHCP function is available and the acquired IP address is available, the camera will load IP address that acquired by DHCP. Or execute (3).
- (3) Acquire LLA.

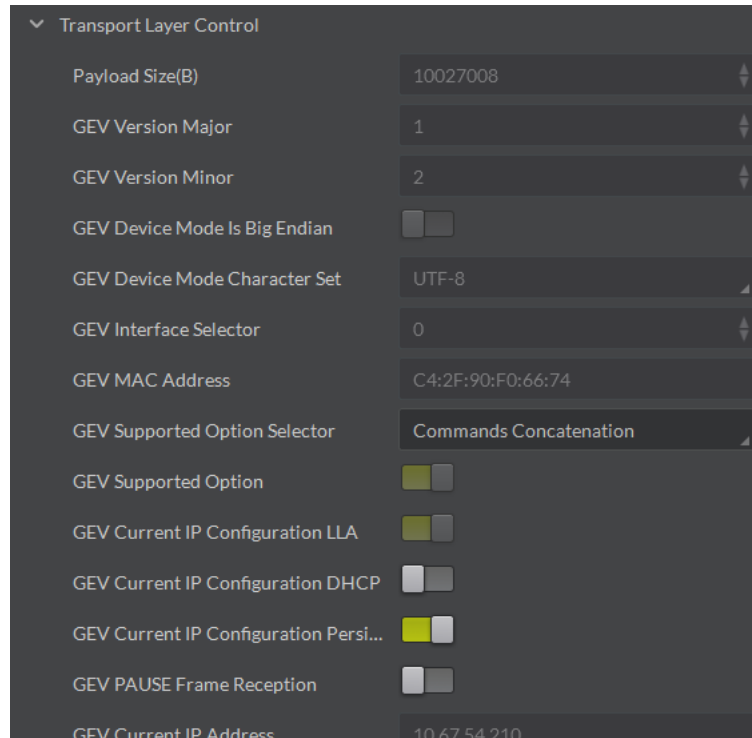

Figure 3-59 The Transport Layer Control Interface

### 3.11.2 Efficient Bandwidth and Setting

Packet Size and Packet Delay control the 1000M Ethernet's actual bandwidth. The theoretical calculation of 1000M network port's image loading bandwidth is:  

$$\text{BandWidth} = ((\text{PacketSize} - (\text{IP} + \text{UDP} + \text{GVSP Header})) / (\text{PacketSize} + \text{MACHeader} + \text{CRC} + \text{Packet-Delay})) * 1000\text{M}/\text{bps}.$$

Normally, IP/UDP/GVSP Header takes 36 bytes. MAC Header takes 14 bytes. CRC takes 4 bytes. Taking setting Packet Size 1500 and Packet Delay 400 as an example, the actual network bandwidth is  

$$\text{BandWidth} = (1500 - 36) / (1500 + 14 + 4 + 400) * 1000\text{Mbps} = 759.36 \text{ Mbps}$$

The actual network bandwidth is smaller than the theoretical one because of the network message, GVCP, GCSP leader, Trailer and any other overheads.

Set Packet Size (GEV SCPS Packet Size) value and Packet Delay (GEV SCPD) value by using the slider and the input box. You can set these two parameters according to the computer performance and the network card performance in the condition of no data package loss, as shown in Figure 3-60.

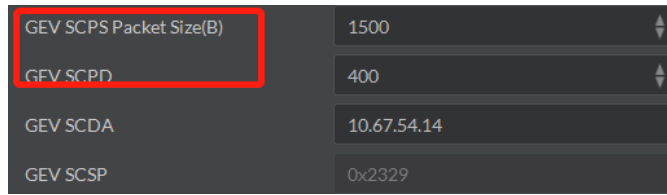

Figure 3-60 Packet Size Setting And Packet Delay Setting

### 3.12 User Parameter and Preference Setting

#### 3.12.1 Parameters Saving and Loading

The camera can save four groups of parameters, including one group of factory parameter and three groups of configurable parameters. You can save currently configured parameter and set corresponded default parameter when logging in at next time in User Set Control in the attribute list.

Configuration method: select one of the parameter names in the drop-down box in User Set Selector. Save current parameter setting. In the drop-down box of User Set Default, select one of the parameters when the client runs, as shown in Figure 3-61. Click Execute in both User Set Save and User Set Load.

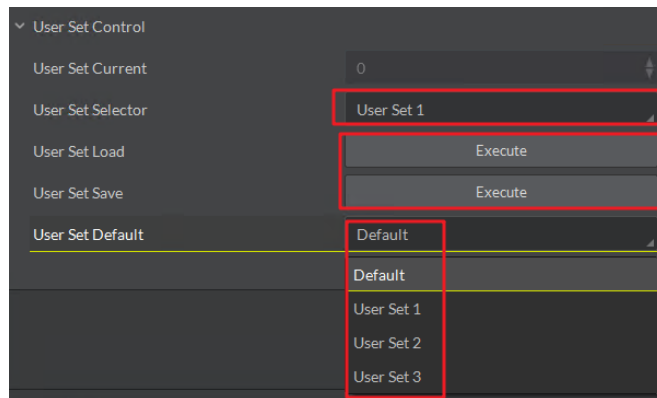

Figure 3-61 Parameters Saving And Loading

Figure 3-62 shows the relationship among four groups of parameters.

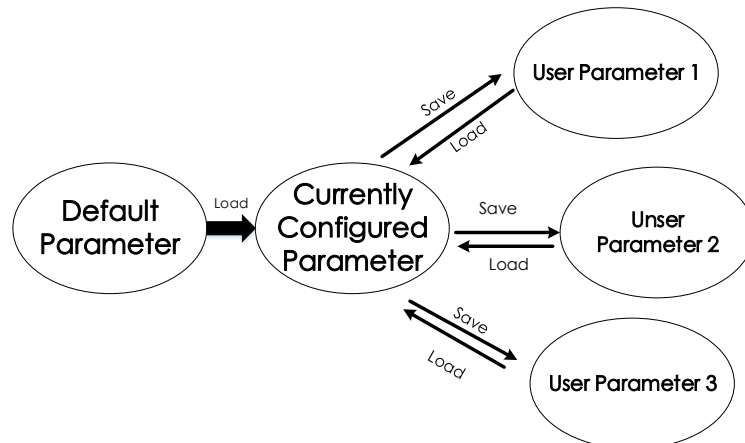

Figure 3-62 The Relationship Among Four Groups of Parameters

### 3.12.2 Embedded Information

The camera supports embedding information into the image data. The current supporting embedded information is:

- Timestamp
- Analog gain
- Exposure time
- Average brightness
- White balance gain
- Frame number
- Trigger counter
- ROI

The above eight information will be embedded in the image data one by one according to the client. If the information is not available, it will not be embedded.

The AOI will not affect the embedding. If the region of AOI is small, the first line of the image data is not enough for embedding. Then the information will be embedded in the second line.

Each embedded information of the available data will be put in the least 8 significant bits (No matter in MONO8 or RGB24).

The Embedded information is as following:

**Timestamp:** Take four bytes: transmission with four available data.

**Data format:** The data format of the timestamp is shown in Figure 3-63.

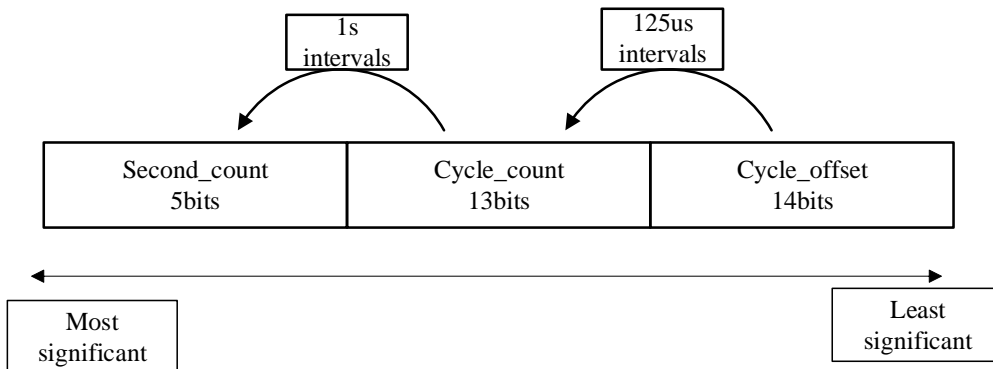

Figure 3-63 Timestamp Format

**Analog gain:** Take four bytes: transmission with four available data. Connect the least significant 8 bit of the four data together.

**The data format of analog gain:** Show the connected data directly. The range is form 0 to 1023. The Most Significant Bits will complement 0 automatically.

**Exposure time:** Take four bytes: transmission with four available data. Connect the least significant 8 bit of the four data together.

**The data format of the exposure time:** The connected least significant 8 bit of the four data is the number of the exposure line. Multiply the line number to  $25.8\mu s$ . The result is the exposure time. The unit is  $\mu s$ .

**Average Brightness:** Take four bytes: transmission with four available data. Connect the least significant 8 bit of the four data together.

**The data format of the average brightness:** Show the connected data directly. The range is form 0 to 4095. The Most Significant Bits will complement 0 automatically.

**White balance gain:** Contains three components of gain. It consumes 8 bytes in total, including two bytes for R channel of Gain, two bytes for G channel of Gain and four bytes for B channel of Gain. In other words,

the transmission uses eight available image data.

**Data format of white balance gain:** Each channel consumes 2 bytes. The range is form 0 to 4095.

**Frame number:** Take four bytes.

**Frame number format:** Connect four bytes directly. The range is form 0 to 2<sup>32</sup>.

**Trigger counter:** Take 4 bytes. The range is from 0 to 2<sup>32</sup>.

**ROI:** Take three bytes in the initial position. The length and the width consume three bytes.

The data format of ROI:

- (1) The initial position of ROI takes three bytes. The length and the width consume three bytes.
- (2) The initial coordinate of ROI' column takes one and a half bytes. The initial coordinate of ROI's row takes one and a half bytes. The column coordinate is in the front of the row coordinate. The coordinate of the length and the width also consume one and a half bytes respectively.

Click Image Format Control in the attribute list. Select Embedded Image Info Selector. Choose the parameter in the drop-down box and finish setting, as shown in Figure 3-64.

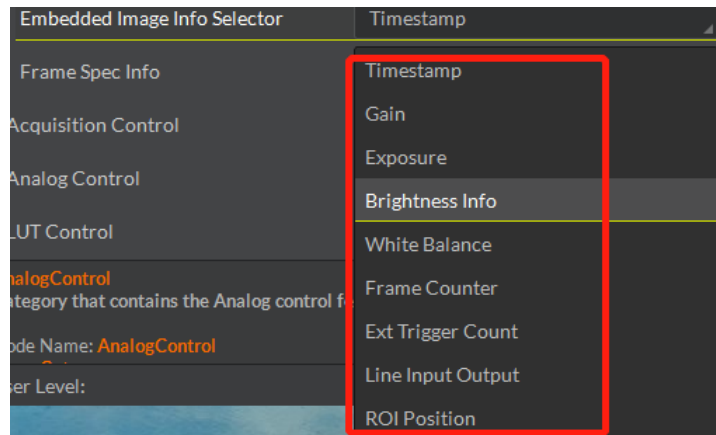

Figure 3-64 Embedded Information

### 3.13 Firmware Updating

Support firmware updating via LAN. After selecting available device in the device list, open Tool>Firmware Updating Tool in the Menu. Select available firmware updating kit, as shown in Figure 3-65.

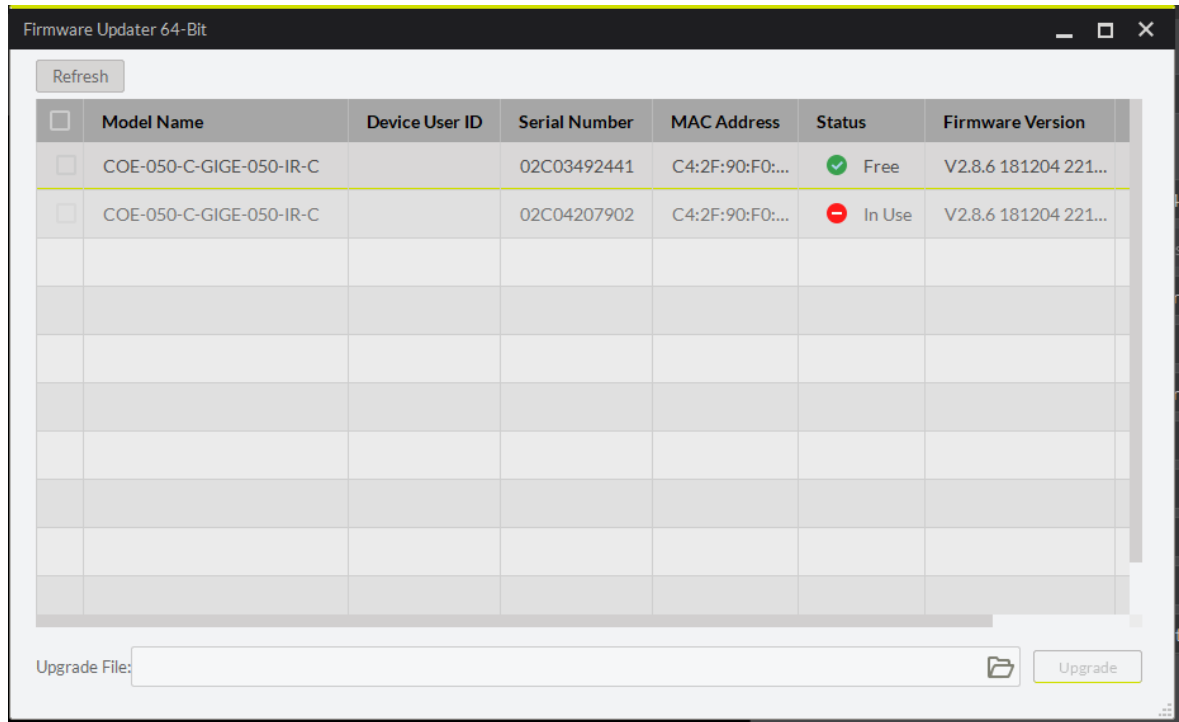

Figure 3-65 Firmware Update

## Chapter 4 Troubleshooting

### 4.1 Indicator Status Definition

Table 4-1 LED Indicator Status

LED Status	Definition
Steady On	The LED indicator keeps lights on all the time
Unlit	The LED indicator keeps unlit all the time
Fast Flicker	The LED indicator flickers every 200ms to 300ms
Slow Flicker	The LED indicator flickers every 1000ms.
Extreme Slow Flicker	The LED indicator flickers every 2000ms.

### 4.2 Indicator Status Description

Table 4-2 LED Status Description

Indicator Status		Camera Status
Indicator in Red	Indicator in Blue	
-	-	The camera is off or hardware damaged.
-	Steady On	The camera is starting up.
Fast Flicker	-	Uboot loading failed.
Extreme Slow Flicker	-	IP address confliction or connection error
-	Slow Flicker	Idle while the camera is in the internal trigger mode.
-	Fast Flicker	Transmitting image while the camera is in the internal trigger mode.
	Extreme Slow Flicker	Transmitting image while the camera is in the external trigger mode.
The indicator flickers red and blue alternately every 1 second.		Upgrading the firmware.
Slow Flicker	-	Camera works normally but is not able to transmit data.
Steady on	-	Upgrading the firmware failed. Contact the technical support.

### 4.3 FAQ

Table 4-3 FAQ

No	Problem Description	Possible Reasons	Solutions
1	1. The camera cannot be detected by the client software. 2. The camera is detected by the client software but connecting failed.	1. The camera does not work properly. 2. The network cable is disconnected. 3. The camera and the PC that runs the OECS client software are not in the same subnet.	1. Confirm if the power supply of camera is well connected (via LED indicator), and the network connects properly (via network interface indicator). 2. Use OECS IP Configurator to detect the camera and change the IP address. 3. Confirm if the GenICam and network Filter driver are installed on the PC.
2	The camera is in read-only status.	The camera is connected with another client software.	Plug out the network cable, and replace it 3 seconds later.
3	The live view of camera is black.	1. The iris is closed. 2. Camera error	1. Open the iris. 2. Reboot the camera.
4	Camera cannot be triggered	1. Incorrect cable connection. 2. The camera works in the internal trigger mode	Make sure the trigger mode is correct and the external trigger is well connected.
5	The live view and image is normal, while the image saved could not be displayed properly.	The image format mismatches.	Make sure the image format what you saved is supported.



# OPTO ENGINEERING

---

## EUROPE

---

### **Opto Engineering Europe Headquarters**

Circonvallazione Sud, 15  
46100 Mantova, IT  
phone: +39 0376 699111  
eu@opto-e.com

### **Opto Engineering Germany**

Marktplatz 3  
82031 Grünwald  
phone: +49 (0)89 693 9671-0  
de@opto-e.com

### **Opto Engineering Russia**

*official partner*  
ViTec Co., Ltd, Fontanka emb., 170  
Saint-Petersburg, 198035, RU  
phone: +7 812 5754591  
info@vitec.ru

---

## UNITED STATES

---

### **Opto Engineering USA**

11321 Richmond Ave  
Suite M-105, Houston, TX 77082  
phone: +1 832 2129391  
us@opto-e.com

---

## ASIA

---

### **Opto Engineering China**

Room 1903-1904, No.885, Renmin  
RD  
Huangpu District 200010  
Shanghai, China  
phone: +86 21 61356711  
cn@opto-e.com

### **Opto Engineering Taiwan**

Opto Engineering Southeast Asia  
LTD.  
4F., No.153, Sec. 2, Shuangshi Rd.,  
Banqiao Dist., New Taipei City  
22043, Taiwan (R.O.C)  
phone: +886 282522188  
tw@opto-e.com

### **Opto Engineering Japan**

*official partner*  
Optart Corporation  
4-54-5 Kameido Koto-ku  
Tokyo, 136-0071 Japan  
phone: +81 3 56285116  
jp@opto-e.com

### **Opto Engineering Korea**

*official partner*  
Far Island Corporation Ltd.  
Seoil Building #703, 353 Sapyeong-  
daero,  
Seocho-gu, Seoul, Korea 06542  
phone: +82 70 767 86098  
phone: +82 10 396 86098  
kr@opto-e.com